

# Radio unit with LoRaWAN® for WIKA measuring instruments

## For applications in hazardous areas

### Model NETRIS®3

WIKA data sheet AC 40.03



for further approvals,  
see page 5



#### Applications

- Data transmission from measuring instruments for preventive maintenance and also monitoring of machinery for big-data analysis in a cloud
- Process industry: Oil and gas, chemical and petrochemical industries, water and wastewater and power generation
- For use in hazardous areas

#### Special features

- IIoT-capable with LoRaWAN® transmission
- Battery-operated LoRa® radio transmission based on LPWAN technology
- High transmission range for the measured values (up to 10 km) with long battery life (up to 10 years)
- Exchange of the radio unit possible in ATEX zones



WIKA radio unit, model NETRIS®3

#### Description

The model NETRIS®3 IIoT-capable WIKA radio unit is used wherever centralised, web-based, remote monitoring of measuring instrument data is required.

The Ex radio unit already receives the data digitally from a WIKA measuring instrument via the intrinsically safe interface. The fully encapsulated instrument with IP65 ingress protection transmits the received data continuously to a cloud via configurable data packets with LoRaWAN®.

Battery-operated radio transmission via LoRa® ("long range") is based on LPWAN technology ("low power wide area network") to enable high transmission ranges and long battery life.

The radio unit is connected to a suitable WIKA measuring instrument via the attached plug connector (M12 or angular connector). The exchange of the radio unit within the ATEX zone during operation is also possible.

The simple web configuration via the cloud and the LoRaWAN® network ("long range wide area network") enables the complete end-to-end encryption with bidirectional communication for safe IIoT applications.

The WIKA radio unit NETRIS®3 is part of the WIKA IIoT solution. With this, WIKA offers a holistic solution for your digitalisation strategy.

## Installation example



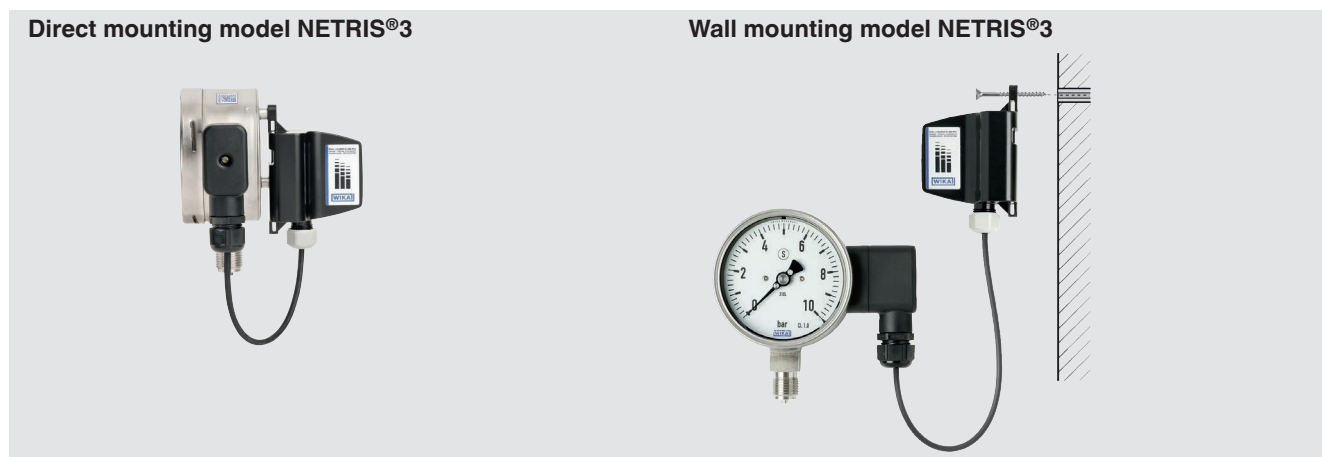

### WIKA radio unit, model NETRIS®3 with mounted model PGU2x.100 pressure gauge



#### Mounting variants for the WIKA model NETRIS®3 radio unit

The radio unit can be mounted either by direct mounting to the WIKA measuring instrument or remotely in a more suitable location.

## Specifications

Overview of versions of suitable WIKA measuring instruments		
Model		Description
	<b>PGU2x.100</b>	Bourdon tube pressure gauge → See data sheet PV 42.03
	<b>TGU</b>	Gas-actuated thermometers → See data sheet TV 17.13
	<b>TRU</b>	Miniature resistance thermometer → See data sheet TE 63.03
	<b>FLRU</b>	Reed level transmitter → See data sheet LM 20.13
	<b>PEU-2x</b>	Pressure sensor → See data sheet PE 87.23

Basic information	
<b>Case</b>	Grilamid TR 90 UV
<b>Mounting</b>	Mounting kit for NETRIS®3, all Mounting variants → Included in delivery

Radio standard	
<b>LoRa®</b>	
LoRaWAN® specification	LoRaWAN® 868 MHz EU
LoRaWAN® protocol	Version 1.0.3
Functions	<ul style="list-style-type: none"> <li>■ Registration</li> <li>■ Configuration of measuring and transmission rate</li> <li>■ Sending measured values</li> <li>■ Alarm management</li> </ul>
Frequency range	863 ... 870 MHz
Range in free field <sup>1)</sup>	Typically 10 km
Transmission power	12 dBm
Antenna	Internal
Max. output power	14 dBm
Measuring rate	10 seconds up to transmission rate, max. 18 hours
Transmission rate	1 minute to 7 days (maximum transmission rate limited by ETSI EN300 220)
Safety	Full end-to-end encryption → For details on security, see website: <a href="https://lora-alliance.org">https://lora-alliance.org</a>

1) The range depends on the topography. 10 km can be achieved in free field conditions with a spreading factor of 12.

Voltage supply and performance data	
<b>LoRa®</b>	
Battery	Lithium thionyl chloride battery (model SAFT LM17500), potted
Battery voltage	DC 3 V
Battery life <sup>1)</sup>	< 10 years

1) At reference conditions a measurement and a transmission every hour (24x day) takes place at spreading factor 10.

Electrical connection	
Connection type	Cable length
Angular connector	<ul style="list-style-type: none"> <li>■ 0.19 m [0.623 ft]</li> <li>■ 2.85 m [9.35 ft]</li> </ul>
Circular connector M12 x 1 (4-pin)	<ul style="list-style-type: none"> <li>■ 0.5 m [1.64 ft]</li> <li>■ 2.85 m [9.35 ft]</li> </ul>

## Pin assignment

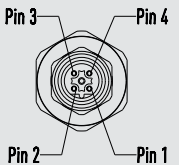
Circular connector M12 x 1 (4-pin)									
	<table border="1"> <tr> <td>1</td> <td>GND</td> </tr> <tr> <td>2</td> <td>UWI: SSM → CM</td> </tr> <tr> <td>3</td> <td>VCC</td> </tr> <tr> <td>4</td> <td>UWI: CM → SSM</td> </tr> </table>	1	GND	2	UWI: SSM → CM	3	VCC	4	UWI: CM → SSM
1	GND								
2	UWI: SSM → CM								
3	VCC								
4	UWI: CM → SSM								

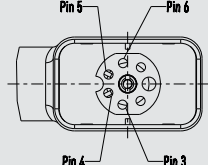
Angular connector									
	<table border="1"> <tr> <td>3</td> <td>UWI: SSM → CM</td> </tr> <tr> <td>4</td> <td>UWI: CM → SSM</td> </tr> <tr> <td>5</td> <td>GND</td> </tr> <tr> <td>6</td> <td>VCC</td> </tr> </table>	3	UWI: SSM → CM	4	UWI: CM → SSM	5	GND	6	VCC
3	UWI: SSM → CM								
4	UWI: CM → SSM								
5	GND								
6	VCC								

### Legend

UWI	Unified WIKA interface (UWI)
GND	Ground
VCC	Voltage at the common current collector
SSM	Sensor model
CM	Communication module

Operating conditions	
Ambient temperature range	-40 ... +60 °C [-40 ... +140 °F]
Storage temperature range	-40 ... +70 °C [-40 ... +158 °F]
Relative humidity, non-condensing	20 ... 90 %, non-condensing
Vibration resistance per IEC 60068-2-6	a = 1 g (7 ... 18 Hz)
	10 ... 14.53 Hz
	A = 0.8 mm (18 ... 50 Hz)
	a = 5 g (50 ... 200 Hz) <sup>1)</sup>
Shock resistance per IEC 60068-2-31 <sup>1)</sup>	25 g, 6 ms
Free fall per IEC 60068-2-31	
Individual packaging	1.2 m [3.94 ft]
Multiple packaging	0.5 m [1.6 ft]
Ingress protection per IEC/EN 60529	IP65

1) Mounting with cable ties can only be made under vibration-free conditions.

## LPWAN infrastructure

A measuring instrument that allows remote monitoring via radio must be integrated into the IIoT infrastructure. The following schematic representation shows a typical LPWAN infrastructure:

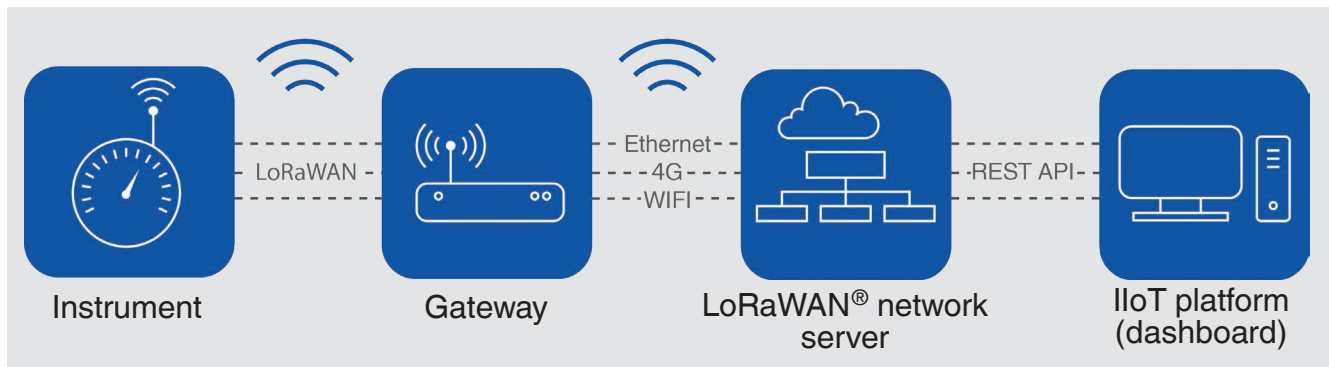



Data from an IIoT-capable measuring instrument is transmitted wirelessly via radio to the gateway. It is ensured that only authorised end devices may communicate with the network server (e.g. LoRaWAN®). For this, the measuring instrument must first be coupled with the network server. In LoRaWAN®, the radio transmission can be up to 10 km. The ranges are dependent on factors such as topography, placement of the gateway or environmental influences.

Measured values from several hundred LoRa®-enabled IIoT instruments, e.g. model PGU23.100 with NETRIS®3, can be collected by a gateway and transmitted to the network server via cable (e.g. Ethernet) or over-the-air (e.g. 4G or WLAN).

In a web-based IIoT platform, the measured data can be stored, alarms can be set and configurations can be made on the instrument. If the limit values are exceeded, alarm messages can be sent as notification via e-mail from the cloud. The measured data can be analysed via the visualisation in the dashboard, thus enabling remote monitoring of the measured values. To support the commissioning of the measuring instrument, the “myWIKa wireless device” app is provided for customers who use a WIKa cloud solution.

## Approvals

Logo	Description	Region
	<b>EU declaration of conformity</b>	European Union
	RED - radio equipment directive The instrument may be used without restriction in the following areas: EU and UK, CH, NO, LI	
	RoHS directive	
	<b>EU declaration of conformity</b>	European Union
	ATEX directive Hazardous areas - Ex i Zone 0 gas II 1G Ex ia [ia Ga] IIC T4 Ga Zone 0 dust II 2D Ex ia [ia Da] IIIB T <sub>200</sub> 135 °C Da	
	<b>IECEx (option)</b> Hazardous areas - Ex i Zone 0 gas Ex ia [ia Ga] IIC T4 Ga Zone 0 dust Ex ia [ia Da] IIIB T <sub>200</sub> 135 °C Da	International

## Safety-related characteristic values (Ex)

Safety-related characteristic values (Ex)			
<b>Ex marking</b>			
<b>Short term input parameters</b>			
Duration	≤ 1 sek.		
Max. voltage U <sub>i</sub>	≤ 8 V		
Max. current I <sub>i</sub>	≤ 500 mA		
<b>Output parameters</b>			
Max. voltage U <sub>o</sub>	≤ 5.88 V		
Max. current I <sub>o</sub>	≤ 200 mA		
Max. power P <sub>o</sub>	≤ 295 mW		
Gases of group IIB	Max. external inductance L <sub>o</sub>	5 mH	0.002 mH
	Max. external capacitance C <sub>o</sub>	10 μF	1.000 μF
Gases of group IIC	Max. external inductance L <sub>o</sub>	1.6 mH	0.001 mH
	Max. external capacitance C <sub>o</sub>	1.3 μF	43 μF
<b>Temperature ranges</b>			
Temperature class	T4		

## Dimensions in mm [in]

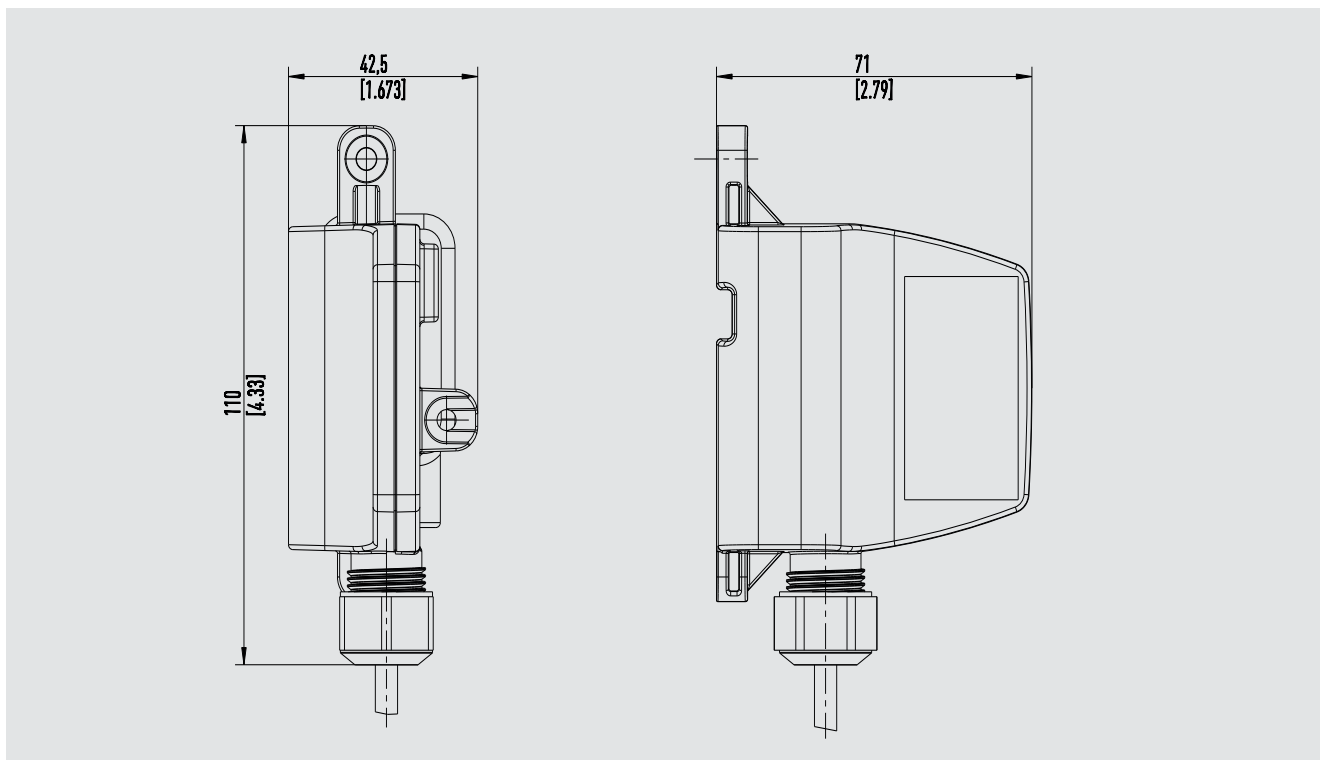

## Ordering information

Model / Connection to platform / Electrical connection / Cable length

The LoRa® brand and the LoRa logo are trademarks of Semtech Corporation.  
LoRaWAN® is a trademark used under licence from LoRa-Alliance®.

© 03/2023 WIKA Alexander Wiegand SE & Co. KG, all rights reserved.  
The specifications given in this document represent the state of engineering at the time of publishing.  
We reserve the right to make modifications to the specifications and materials.

