

# Submersible pressure sensor

## High-performance

### Model LH-20

WIKA data sheet PE 81.56



#### Applications

- Deep well and borehole measurements
- Groundwater monitoring
- Level measurement in open bodies of water
- Sewage lift and pumping stations
- Settling ponds and rainwater basins

#### Special features

- Slimline design
- Scalable measuring range (option)
- Resistant against the harshest environmental conditions
- Reliable and secure by double-sealed design
- Titanium case for especially high resistance (option)



#### Submersible pressure sensor model LH-20

Fig. left: Stainless steel

Fig. right: Titanium

## Description

#### For the most demanding measurement tasks

The model LH-20 submersible pressure sensor has been designed for the most demanding of level measurement tasks. A slimline design, highest accuracies, low temperature errors and an adjustable measuring range ensure the suitability of the LH-20 for all submerged level measurements.

The model LH-20 submersible pressure sensor can adapt to countless applications and measuring media through a large number of features and options. Depending on the requirements, this submersible pressure sensor is available with, amongst other things, a titanium case, PUR/PE/FEP cable, 0.1 % accuracy, HART®, scalability or parallel temperature output signal.

For operation in hazardous environments, the model LH-20 submersible pressure sensor is also available in an intrinsically safe version. For potable and fresh water

applications, a drinking water conformant product variant is possible in accordance with KTW and ACS.

#### Hermetically sealed, robust and durable

The model LH-20 submersible pressure sensor has been engineered for use in the harshest environments. Through a double, redundant sealing concept, it is permanently hermetically sealed. A robust design from stainless steel or titanium, with a spring-reinforced cable seal, ensures a long service life, even under the big mechanical loads of installation and continuous use.

Designs with the highest media resistance using FEP cable and titanium cases, along with the integrated lightning protection, guarantee the longevity of the submersible pressure sensor even under the most adverse environmental influences in aggressive media, in both indoor and outdoor use.

## Measuring ranges

| Gauge pressure    |                 |           |            |            |           |           |
|-------------------|-----------------|-----------|------------|------------|-----------|-----------|
| bar               | Measuring range | 0 ... 0.1 | 0 ... 0.16 | 0 ... 0.25 | 0 ... 0.4 | 0 ... 0.6 |
|                   | Overload safety | 15        | 20         | 30         | 30        | 35        |
|                   | Measuring range | 0 ... 1   | 0 ... 1.6  | 0 ... 2.5  | 0 ... 4   | 0 ... 6   |
|                   | Overload safety | 35        | 50         | 50         | 65        | 90        |
|                   | Measuring range | 0 ... 10  | 0 ... 16   | 0 ... 25   |           |           |
|                   | Overload safety | 90        | 130        | 130        |           |           |
| inWC              | Measuring range | 0 ... 50  | 0 ... 100  | 0 ... 150  | 0 ... 250 |           |
|                   | Overload safety | 8,000     | 12,000     | 12,000     | 14,000    |           |
| psi               | Measuring range | 0 ... 5   | 0 ... 10   | 0 ... 15   | 0 ... 25  | 0 ... 50  |
|                   | Overload safety | 400       | 500        | 700        | 700       | 900       |
|                   | Measuring range | 0 ... 100 | 0 ... 160  | 0 ... 200  | 0 ... 300 |           |
|                   | Overload safety | 1,300     | 1,900      | 1,900      | 1,900     |           |
| mH <sub>2</sub> O | Measuring range | 0 ... 1   | 0 ... 1.6  | 0 ... 2.5  | 0 ... 4   | 0 ... 6   |
|                   | Overload safety | 150       | 200        | 300        | 300       | 350       |
|                   | Measuring range | 0 ... 10  | 0 ... 16   | 0 ... 25   | 0 ... 40  | 0 ... 60  |
|                   | Overload safety | 350       | 500        | 500        | 650       | 900       |
|                   | Measuring range | 0 ... 100 | 0 ... 160  | 0 ... 250  |           |           |
|                   | Overload safety | 900       | 1,300      | 1,300      |           |           |

| Absolute pressure |                 |           |           |         |         |          |
|-------------------|-----------------|-----------|-----------|---------|---------|----------|
| bar               | Measuring range | 0 ... 1.6 | 0 ... 2.5 | 0 ... 4 | 0 ... 6 | 0 ... 10 |
|                   | Overload safety | 50        | 50        | 60      | 90      | 90       |
|                   | Measuring range | 0 ... 16  | 0 ... 25  |         |         |          |
|                   | Overload safety | 130       | 130       |         |         |          |

The given measuring ranges are also available in mbar, kPa and MPa.

## Output signals

| Output signals |   |
|----------------|---|
| Standard       | 4 ... 20 mA   |
| Option         | 4 ... 20 mA and HART® signal, additional Pt100 measuring signal |

### Load in Ω

The load depends on the selected output signal and measuring deviation (see page 3).

- 4 ... 20 mA with measuring deviation 0.1 %:  $\leq (\text{power supply} - 9.6 \text{ V}) / 0.022 \text{ A}$
- 4 ... 20 mA with measuring deviation 0.2 %:  $\leq (\text{power supply} - 8 \text{ V}) / 0.022 \text{ A}$
- 4 ... 20 mA and HART® signal:  $\leq (\text{power supply} - 9.6 \text{ V}) / 0.022 \text{ A}$

## Voltage supply

### Power supply

The power supply depends on the selected output signal and measuring deviation (see page 3).

- 4 ... 20 mA with measuring deviation 0.1 %: DC 9.6 ... 30 V
- 4 ... 20 mA with measuring deviation 0.2 %: DC 8 ... 30 V
- 4 ... 20 mA and HART® signal: DC 9.6 ... 30 V

When being operated in hazardous areas, the submersible pressure sensor must be powered via a repeater power supply (see "Accessories").

## Additional Pt100 measuring element

The HART® version has an additional Pt100 measuring element for measuring the medium temperature.

- Pt100 per DIN EN 60751
- Measuring range -50 ... +100 °C [-58 ... +212 °F]
- Resolution of 1 °K

## Reference conditions

### Temperature

15 ... 25 °C [59 ... 77 °F]

### Atmospheric pressure

860 ... 1,060 mbar [86 ... 106 kPa /12.5 ... 15.4 psig]

### Humidity

45 ... 75 % r. h.

### Mounting position

Calibrated in vertical mounting position, with process connection facing downwards.

## Accuracy specifications

### Measuring deviation at reference conditions

| Measuring deviation |                          |
|---------------------|--------------------------|
| Standard            | $\leq \pm 0.2$ % of span |
| Option              | $\leq \pm 0.1$ % of span |

By setting a turndown of greater than 5:1, a higher measuring deviation applies.  
Measuring deviation determined using the limit point method per IEC 60770.

### Temperature error of the zero point in the temperature range 0 ... 80 °C [32 ... 176 °F]

- with measuring deviation  $\leq \pm 0.2$  % of span
  - Standard, without turndown  $\leq \pm 0.15$  % of span/10 K
  - Turndown  $\leq 5:1$   $\leq \pm 0.20$  % of span/10 K
  - Turndown  $> 5:1$   $\leq \pm 0.25$  % of span/10 K
  
- with measuring deviation  $\leq \pm 0.1$  % of span
  - Standard, without turndown  $\leq \pm 0.05$  % of span/10 K
  - Turndown  $\leq 5:1$   $\leq \pm 0.10$  % of span/10 K
  - Turndown  $> 5:1$   $\leq \pm 0.15$  % of span/10 K

### Long-term drift

$\leq \pm 0.1$  % of span/year

### Settling time (0 ... 63 %)

Depending on the output signal the following settling times apply:

- 4 ... 20 mA: 100 ms
- 4 ... 20 mA, HART® signal: 200 ms

### Scalability (turndown)

The HART® version enables scaling of the measuring range (turndown).

It is recommended that turndown is not set to over 5:1, since the accuracy can decrease dependant on the scaling.

## Operating conditions

### Ingress protection (per IEC 60529)

IP68

### Immersion depth

to 250 m [820 ft]

### Vibration resistance (per IEC 60068-2-6)

4 g (at 5 ... 100 Hz)

### Lightning protection

Nominal discharge current  $\geq 5$  kA, response time  $< 25$  ns

### Temperatures

The permissible temperature ranges are dependent on the cable material used:

|          |            |                                  |
|----------|------------|----------------------------------|
| Medium:  | PE cable:  | -40 ... +60 °C [-40 ... +140 °F] |
|          | PUR cable: | -40 ... +80 °C [-40 ... +176 °F] |
|          | FEP cable: | -40 ... +80 °C [-40 ... +176 °F] |
| Ambient: | PE cable:  | -40 ... +60 °C [-40 ... +140 °F] |
|          | PUR cable: | -40 ... +85 °C [-40 ... +185 °F] |
|          | FEP cable: | -40 ... +85 °C [-40 ... +185 °F] |
| Storage: | PE cable:  | -40 ... +80 °C [-40 ... +176 °F] |
|          | PUR cable: | -40 ... +80 °C [-40 ... +176 °F] |
|          | FEP cable: | -40 ... +80 °C [-40 ... +176 °F] |

### Maximum tension force on the cable

1,200 N [270 lbf]

### Weight

- Submersible pressure sensor: approx. 370 g
- Cable: approx. 100 g/m [1.08 oz/ft]

## Explosion protection (option)

| Ignition protection types |   |
|---------------------------|---|
| ATEX                      | II 1G Ex ia IIC T6 Ga<br>II 2G Ex ia IIC T6 Gb  |
| FM                        | IS class I, div. 1, groups A, B, C, D<br>Class II, div. 1, groups E, F, G<br>Class III, T6. Type 4X/6P<br>Class I zone 0 AEx ia IIC |
| CSA                       | Class I, div. 1, groups A, B, C, D<br>Class II, div. 1, groups E, F, G<br>Class III, T6. Encl. Type 4X<br>Ex ia IIC                 |

### Ambient temperature ranges

#### ■ ATEX for use as category 1G / Ga equipment (for zone 0)

Ambient: Temperature class T6: -20 ... +50 °C [-4 ... +122 °F]  
Temperature class T1 ... T5: -20 ... +60 °C [-4 ... +140 °F]

#### ■ ATEX for use as category 2G / Gb equipment (for zone 1)

Ambient: Temperature class T6: -40 ... +66 °C [-40 ... +150 °F]  
Temperature class T1 ... T5: -40 ... +80 °C [-40 ... +176 °F]

#### ■ CSA (Ex)

Ambient: Temperature class T6: -40 ... +60 °C [-40 ... +140 °F]  
Temperature class T1 ... T4: -40 ... +80 °C [-40 ... +176 °F]

#### ■ FM (Ex)

Ambient: Temperature class T6: -40 ... +60 °C [-40 ... 140 °F]  
Temperature class T1 ... T4: -40 ... +80 °C [-40 ... 176 °F]

## Process connections

The model LH-20 is available in two process connection variants:

| Process connections |                             |
|---------------------|-----------------------------|
| Standard            | M14 x 1 with protective cap |
| Option              | Flush measuring cell        |

## Electrical connections

### Reverse polarity protection

U<sub>+</sub> vs. U<sub>-</sub>

### Overvoltage protection

see lightning protection under “Operating conditions”

### Cable lengths

Cable length to customer requirements, freely selectable

### Connection diagrams

| Cable outlet  |                |                      |
|---|----------------|----------------------|
|  | U <sub>+</sub> | brown                |
|   | U <sub>-</sub> | blue                 |
|   | Shield         | black sheathed cable |

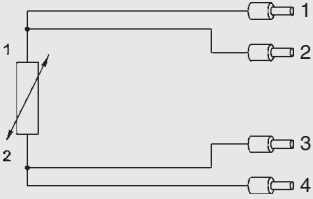
| Pt100 measuring element (4-wire connection)                                       |   |        |
|---|---|--------|
|  | 1 | white  |
|   | 2 | yellow |
|   | 3 | red    |
|   | 4 | black  |

## Materials (wetted)

|                                | Standard             | Option                 |
|--------------------------------|----------------------|------------------------|
| Case                           | Stainless steel 316L | Titanium <sup>1)</sup> |
| Cable material                 | PUR                  | PE, FEP                |
| Sealing material <sup>2)</sup> | FKM                  | EPDM                   |

1) Not available in intrinsically safe version.

2) The model LH-20 is double sealed behind the sensor.

### Sensor

Ceramic Al<sub>2</sub>O<sub>3</sub> 96 %

## Titanium for especially high resistance (option)







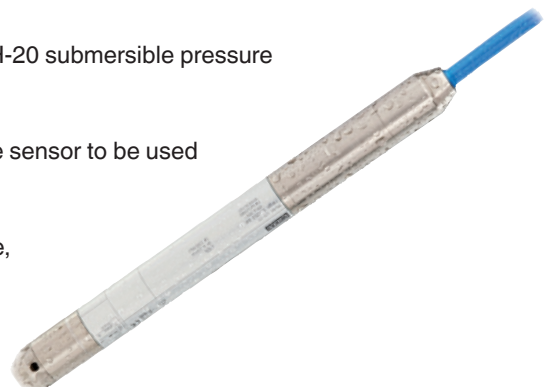

For a particularly high resistance against aggressive media, the model LH-20 submersible pressure sensor is available with a titanium case.

This exceptionally high-quality material enables the submersible pressure sensor to be used under the most adverse conditions.

The highly chemically-resistant titanium design ensures a long service life, even in aggressive media and the most demanding applications.



## Approvals

| Logo  | Description   | Country                     |
|---|---|-----------------------------|
|    | <b>EU declaration of conformity</b> <ul style="list-style-type: none"> <li>■ EMC directive<br/>EN 61326 emission (group 1, class B) and immunity (industrial application)</li> <li>■ RoHS directive</li> <li>■ ATEX directive (option)<br/>Hazardous areas               <ul style="list-style-type: none"> <li>- Ex i Zone 1 gas [II 2G Ex ia IIC T6 Gb]</li> <li>Zone 0 gas [II 1G Ex ia IIC T6 Ga]</li> </ul> </li> </ul>  | European Union              |
|    | <b>FM (option)</b><br>Intrinsically safe apparatus for use in:<br>Class I, division 1 or 2, groups A, B, C, D<br>Class II, division 1 or 2, groups E, F, G<br>Class III, division 1 or 2, in accordance with control drawing<br><br>Equipment protection by intrinsic safety AEx ia for use in:<br>Class I, zone 0, zone 1 or zone 2, group IIC in accordance with control drawing<br><br>Nonincendive apparatus for use in:<br>Class I, division 2, groups A, B, C, D<br><br>Nonincendive for use in:<br>Class I, zone 2, group IIC hazardous (classified) location, type 4X/6P and IP68 | USA                         |
|    | <b>CSA (option)</b><br>Class I, division 1, groups A, B, C, D<br>Class II, division 2, groups E, F, G<br>Class III, T6. Encl. Type 4X<br>Ex ia IIC  | Canada                      |
|   | <b>EAC</b><br>EMC directive   | Eurasian Economic Community |
|  | <b>GOST</b><br>Metrology, measurement technology  | Russia                      |
|  | <b>BelGIM</b><br>Metrology, measurement technology  | Belarus                     |
|  | <b>UkrSEPRO</b><br>Metrology, measurement technology  | Ukraine                     |
|  | <b>DNOP (MakNII)</b> <ul style="list-style-type: none"> <li>■ Mining</li> <li>■ Hazardous areas</li> </ul>  | Ukraine                     |
|  | <b>DNV GL (option)</b><br>Ships, shipbuilding (e.g. offshore)   | International               |
| -   | <b>CRN</b><br>Safety (e.g. electr. safety, overpressure, ...)   | Canada                      |



## Certificates (option)

- Drinking water declaration of conformity in accordance with KTW and ACS <sup>1)</sup>
- Test report <sup>2)</sup>

1) Only available in combination with PE cable and not available in intrinsically safe version

2) The test report documents the product-specific instrument specifications and include a detailed listing of the single measured values of the acceptance test.

Approvals and certificates, see website

## Dimensions in mm [in]

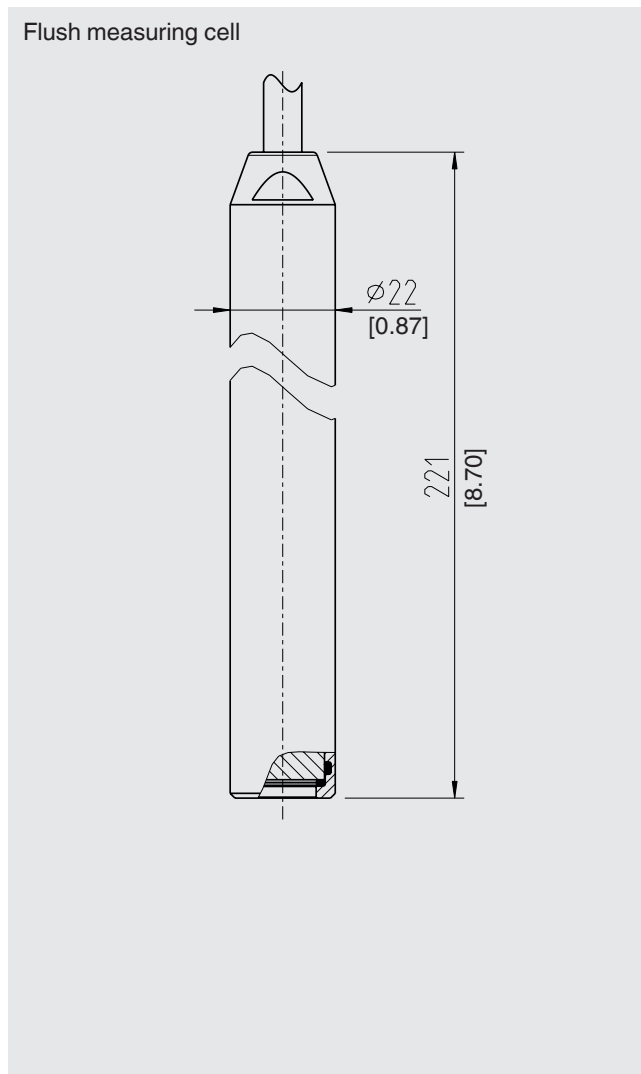
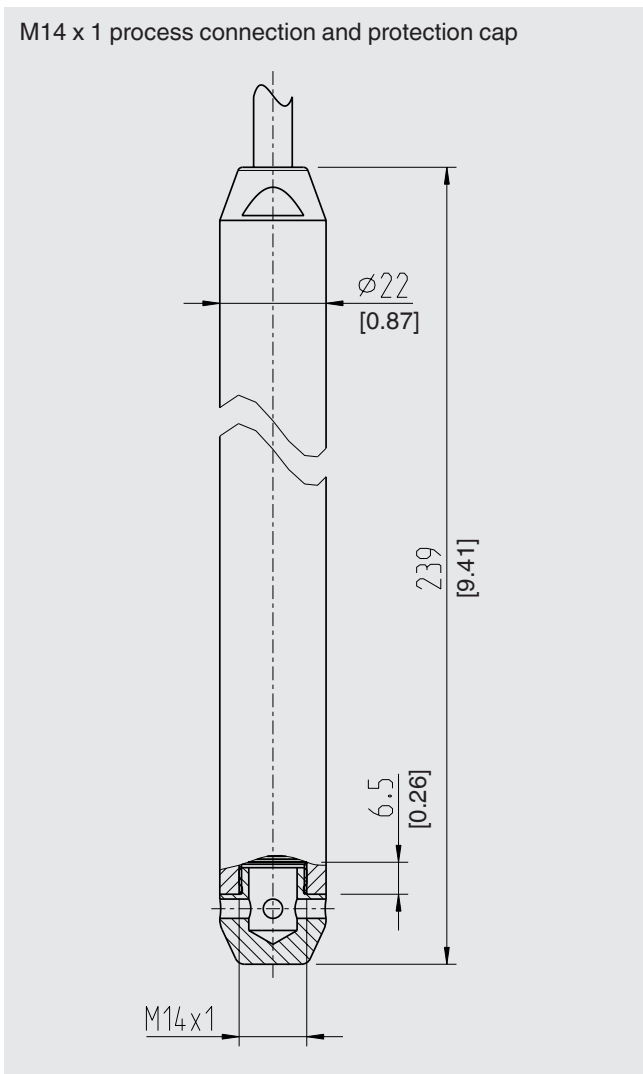

## Accessories

|   | Description   | Order number  |
|---|---|---|
|    | <p><b>Cable strain relief clamp</b><br/>The cable strain relief clamp ensures easy and secure mechanical fastening of the submersible pressure sensor's cable. It serves to guide the cable to prevent mechanical damage and to reduce the action of tensile stresses.</p>  | 14052336  |
|    | <p><b>Additional weight</b><br/>The additional weight increases the dead weight of the submersible pressure sensor. It simplifies the lowering in monitoring wells, narrow shafts and deep wells. It effectively reduces negative environmental influences of the measuring medium (e.g. turbulent flows) on the measuring result.</p> <p>The additional weight is available in two versions:</p> <ul style="list-style-type: none"> <li>■ Stainless steel 316L, approx. 350 g [12.3 oz], length 120 mm [4.7 in]</li> <li>■ Titanium, approx. 350 g [12.3 oz], length 214.5 mm [8.4 in]</li> </ul> <p>It is recommended that the design of the additional weight is selected in line with the case material of the submersible pressure sensor.</p> | 14052322 (316L)<br>14052330 (titanium)  |
|    | <p><b>Terminal box</b><br/>The terminal box, with IP67 ingress protection and waterproof ventilation element, provides a moisture-free electrical termination for the submersible pressure sensor. It should be mounted in a dry environment, outside any shafts or vessels, or directly in the switch cabinet.</p>   | 14052339  |
|   | <p><b>Intrinsically safe repeater power supply, model IS Barrier</b><br/>Input 0/4 ... 20 mA, supplying and non-supplying Bidirectional HART® signal transmission</p> <p>For details see data sheet AC 80.14</p>  | 14117118  |
|  | <p><b>Display module DIH52 and DIH62</b><br/>5-digit display, 20-segment bar graph, without separate power supply, with additional HART® functionality. Automatic adjustment of measuring range and span.<br/>"Secondary-master" functionality: Setting the measuring range and unit of the connected transmitter using HART® standard commands possible. Optionally explosion protection per ATEX</p>  | on request  |
|  | <p><b>HART® modem with USB, RS-232 or Bluetooth® interface</b><br/>For scaling the measuring range using a PC via the HART® protocol, a HART® modem with USB, RS-232 or Bluetooth® interface is available. The modem communicates with all registered HART® field instruments and can be used with the most popular HART®-compatible software programs.</p>   | 7957522 (RS-232 interface)<br>11025166 (USB interface)<br>11364254 (Bluetooth® interface) |

### Ordering information

Model / Measuring range / Output signal / Accuracy / Cable material / Cable length / Case / Process connection / Sealing / Approval / Certificate / Accessories

© 11/2012 WIKA Alexander Wiegand SE & Co. KG, all rights reserved.  
The specifications given in this document represent the state of engineering at the time of publishing.  
We reserve the right to make modifications to the specifications and materials.

