



S8000 Remote Chilled Mirror Hygrometer User's Manual



97228 Issue 4
March 2018

Please fill out the form(s) below for each instrument that has been purchased.

Use this information when contacting Michell Instruments for service purposes.

Analyzer	
Code	
Serial Number	
Invoice Date	
Location of Instrument	
Tag No	

Analyzer	
Code	
Serial Number	
Invoice Date	
Location of Instrument	
Tag No	

Analyzer	
Code	
Serial Number	
Invoice Date	
Location of Instrument	
Tag No	



S8000 Remote

For Michell Instruments' contact information please go to
www.michell.com

© 2018 Michell Instruments

This document is the property of Michell Instruments Ltd. and may not be copied or otherwise reproduced, communicated in any way to third parties, nor stored in any Data Processing System without the express written authorization of Michell Instruments Ltd.

Contents

Safetyvi
 Electrical Safetyvi
 Pressure Safetyvi
 Toxic Materialsvi
 Repair and Maintenancevi
 Calibrationvi
 Safety Conformityvi
 Abbreviationsvii
 Warningsvii

1 INTRODUCTION1

2 INSTALLATION2

2.1 Safety..... 2
 2.2 Unpacking the Instrument..... 2
 2.3 Operating Requirements 3
 2.3.1 Environmental Requirements 3
 2.3.2 Electrical Requirements 3
 2.4 Exterior Layout..... 3
 2.4.1 Front Panel..... 3
 2.4.2 Rear Panel..... 4
 2.5 Rear Panel Connections 6
 2.5.1 Power Supply Input..... 6
 2.5.2 Analog Output Connections..... 7
 2.5.3 Alarm Output Connections 8
 2.5.4 Dew-Point Sensor Connection 10
 2.5.5 Remote PRT Probe 10
 2.5.6 USB Communications Port Connector..... 11
 2.5.7 Ethernet Port (Optional) 11
 2.5.8 RS232/485 Port (Optional)..... 12
 2.5.9 Remote Pressure Transducer (Optional) 13

3 USER INTERFACE14

3.1 Main Display 14
 3.1.1 Main Screen..... 14
 4.1 Operating Cycle..... 22
 4.2 Operating Guide 23
 4.2.1 Description 23
 4.2.2 Operating Practice..... 23
 4.4 First Time Operation 29
 4.5 Operational Functions 29
 4.5.1 DCC Function..... 29
 4.5.2 MAXCOOL Function 29
 4.5.3 Frost Assurance Technology (FAST) 30
 4.5.4 STANDBY Mode..... 30
 4.5.5 Parameter Conversions & Pressure Compensation 30
 4.5.6 Data Logging 30
 4.5.7 Minimum measurable dew points 31

5 MAINTENANCE32

5.1 Safety..... 32
 5.2 Fuse Replacement 32
 5.3 Sensor Mirror Cleaning..... 33

6 CALIBRATION.....34

6.1 Traceability 34

Tables

Table 1	Front Panel	4
Table 2	Rear Panel Controls	5
Table 3	Main Screen Layout	15
Table 4	Operational Status Display	17
Table 5	Sensor Status Display	17
Table 6	DCC Menu	18
Table 7	Logging Menu	19
Table 8	Outputs Menu	20
Table 9	Alarm Menu	20
Table 10	Display Menu	21
Table 11	Network Settings.....	21
Table 12	Calculated Parameters	30

Appendices

Appendix A	Technical Specifications.....	36
	A.1 Dimensions	38
Appendix B	Quality, Recycling & Warranty Information.....	40
Appendix C	Analyzer Return Document & Decontamination Declaration	42

Figures

Figure 1	Front Panel	3
Figure 2	Rear Panel	4
Figure 3	Power Supply Input	6
Figure 4	Analog Output Connectors	7
Figure 5	Alarm Output Connectors.....	9
Figure 6	Dew-Point Sensor Connection.....	10
Figure 8	USB Port Connection.....	11
Figure 9	Ethernet Port	11
Figure 10	Remote Pressure Transducer Connection.....	13
Figure 11	Main Screen.....	14
Figure 12	Main Screen Layout	14
Figure 13	Menu Structure	16
Figure 14	DCC Screen.....	17
Figure 15	Logging Screen	18
Figure 16	Outputs Screen	19
Figure 17	Alarm Screen	20
Figure 18	Network settings	21
Figure 19	Typical Operating Cycle.....	22
Figure 20	Room Measurement Example	24
Figure 21	Sample Block	25
Figure 22	Material permeability comparison.....	26
Figure 23	Formation of condensation.....	27
Figure 24	Minimum Measurable Dew Points.....	31
Figure 25	Power Supply Fuse Replacement	32
Figure 26	Sensor Mirror Cleaning.....	33
Figure 27	Typical Calibration Certificate.....	34
Figure 28	S8000 Remote Dimensions.....	38
Figure 29	Sensor Dimensions	38

Safety

The manufacturer has designed this equipment to be safe when operated using the procedures detailed in this manual. The user must not use this equipment for any other purpose than that stated. Do not apply values greater than the maximum value stated.

This manual contains operating and safety instructions, which must be followed to ensure the safe operation and to maintain the equipment in a safe condition. The safety instructions are either warnings or cautions issued to protect the user and the equipment from injury or damage. Use qualified personnel and good engineering practice for all procedures in this manual.

Electrical Safety

The instrument is designed to be completely safe when used with options and accessories supplied by the manufacturer for use with the instrument. The input power supply voltage limits are 85 to 264 V AC, 47/63 Hz. Refer to Appendix A - Technical Specifications.

Pressure Safety

DO NOT permit pressures greater than the safe working pressure to be applied to the sensor. The specified safe working pressure is 20 barg (290 psig) or 250barg (3625psig) for the high pressure version. Refer to Appendix A - Technical Specifications.

Application of gas pressures higher than the specified maximum will result in potential damage and may render the instrument unsafe and in a condition of incorrect functionality. Only personnel trained in the safe handling of high pressure gases should be allowed to operate this instrument. Refer to Appendix A - Technical Specifications.

Toxic Materials

The use of hazardous materials in the construction of this instrument has been minimized. During normal operation it is not possible for the user to come into contact with any hazardous substance which might be employed in the construction of the instrument. Care should, however, be exercised during maintenance and the disposal of certain parts.

Repair and Maintenance

The instrument must be maintained either by the manufacturer or an accredited service agent. Refer to www.michell.com for details of Michell Instruments' worldwide offices contact information.

Calibration

The recommended calibration interval for the S8000 Remote is one year, unless otherwise specified by Michell Instruments Ltd. The instrument should be returned to the manufacturer, Michell Instruments, or one of their accredited service agents for re-calibration (refer to www.michell.com for details of Michell Instruments' worldwide offices contact information).

Safety Conformity

This product meets the essential protection requirements of the relevant EU directives. Further details of applied standards may be found in the product specification.

Abbreviations

The following abbreviations are used in this manual:

DCC	Dynamic Contamination Correction
FAST	Frost Assurance System Technology
MAXCOOL	Maximum Sensor Cooling
AC	alternating current
atm	pressure unit (atmosphere)
bar	pressure unit (=100 kP or 0.987 atm)
°C	degrees Celsius
°F	degrees Fahrenheit
COM	common
DC	direct current
dp	dew point
ENT	enter (select)
EU	European Union
ft	foot (feet)
g/kg	grams per kilogram
g/m ³	grams per cubic meter
HMI	Human Machine Interface
Hz	Hertz
IEC	International Electrotechnical Commission
in	inch(es)
NI/min	normal liters per minute
lb	pound
mA	milliampere
max	maximum
min	minute(s)
mV	millivolt(s)
N/C	normally closed
N/O	normally open
No	number
ppm _v	parts per million (by volume)
ppm _w	parts per million (by weight)
PRT	Platinum resistance thermometer (typically type Pt100)
psig	pound(s) per square inch (gauge)
rh	relative humidity
RTU	Remote Terminal Unit
scfh	standard cubic feet per hour
SD	card storage device card (memory card for storing datalog files)
sec	second(s)
temp	temperature
USB	Universal Serial Bus
V	Volts

Warnings

The following general warning listed below is applicable to this instrument. It is repeated in the text in the appropriate locations.



Where this hazard warning symbol appears in the following sections, it is used to indicate areas where potentially hazardous operations need to be carried out.

NOTES

1 INTRODUCTION

The S8000 Remote Hygrometer is a high precision instrument used for the measurement of moisture content in air and other gases. Relative humidity and other calculated parameters based on dew point, pressure and temperature of the sample gas can also be displayed. Two pressure options are available: low pressure, allowing measurements at a maximum of 20barg (290psig), and high pressure, allowing measurements at a maximum of 250barg (3625psig).

The S8000 Remote employs an advanced chilled mirror technique which enables it to directly measure dew points in the range -40 to +90°C (-40 to +194°F); -40 to +120°C (-40 to +248°F) for the PEEK and Climatic sensor versions).

2 INSTALLATION

2.1 Safety



It is essential that the installation of the electrical and gas connections to this instrument be undertaken by competent personnel.

2.2 Unpacking the Instrument

Open the box and unpack carefully. Save all the packing materials for the purpose of returning the instrument for re-calibration or any warranty claims.

The accessories box should contain the following items:

- Traceable calibration certificate
- SD memory storage card
- Optics cleaning kit
- USB communications cable
- Remote Pt100 temperature probe
- IEC power cable
- Sensor cable
- Dew-point sensor
- Pressure transducer and cable (optional)

If there are any shortages please notify Michell Instruments immediately (see contact information at www.michell.com).

2.3 Operating Requirements

2.3.1 Environmental Requirements

The operational range of the S8000 Remote sensor is dependant on the temperature of the environment in which it is installed. The sensor is able to measure dew points down to 60°C below ambient temperature, and anywhere up to (but not including) the point of condensation. At higher ambient temperatures the cooling ability of the sensor may be slightly reduced.

2.3.2 Electrical Requirements

The S8000 Remote requires the following electrical supply:

- 85 to 264 V AC, 47/63 Hz, 100 VA max
- Alarm outputs comprise two sets of changeover relay contacts, one set for a **PROCESS** alarm and one set for an **INSTRUMENT FAULT**. Both sets of contacts are rated at 24 V, 1A. **NOTE: This rating must not be exceeded.**

2.4 Exterior Layout

The controls, indicators and connectors associated with the S8000 Remote are located on the front and rear panels of the instrument.

2.4.1 Front Panel



Figure 1 *Front Panel*

No.	Name	Description
1	Touch Screen Display	Displays measured values and enables the user to control the operation of the instrument. See section 3 for information about the touch screen and menu system.
2	SD Slot	Takes an SD card used to store logged data. See section 3.2.2 for further information on how to use data logging.

Table 1 *Front Panel*

2.4.2 Rear Panel

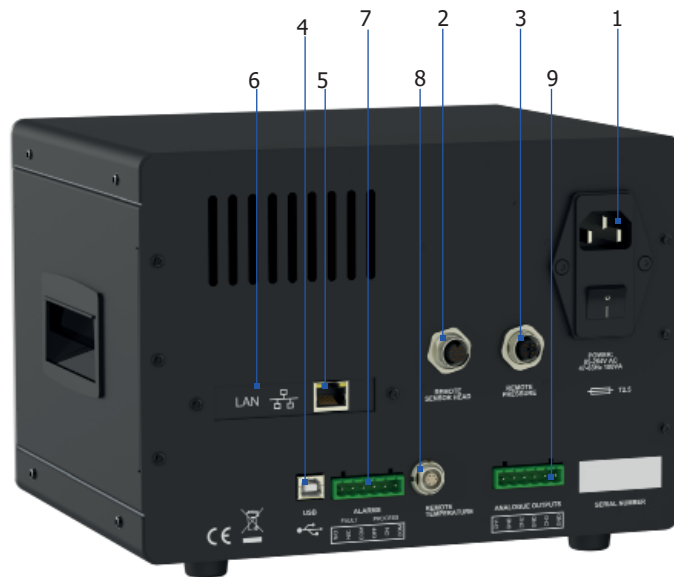

Figure 2 *Rear Panel*

No.	Name	Description
1	Mains Power IEC Socket	Universal power input 85 to 264 V AC, 47/63 Hz Fuse - T2.5A, Glass, 20 x 5mm Features integrated power ON/OFF switch
2	Sensor Connector	Used for connecting the chilled mirror sensor to the instrument via the sensor cable.
3	Pressure Transducer Connector	Used for connecting an external pressure transducer to the instrument.
4	USB Communications Port	Used for connection to an external computer system for running application software (optional).
5	Ethernet Communication Port (Optional)	Used for connection to a network to access measured parameters and control the instrument remotely.
6	RS232/RS485 Communication Port (Optional)	Used for connection to a computer system or DCS to access measured parameters and control the instrument remotely.
7	Alarms	Socket for Process and Fault alarm outputs. Each alarm has one set of potential free, changeover, relay contacts, common (COM), normally closed (N/C) and normally open (N/O). The Process alarm can be configured to operate at a specified level on any of the measured or calculated parameters. Refer to Section 3.2.4.
8	Remote Temperature Probe	6-Pin Lemo socket for connection of remote Pt100 temperature probe.
9	Analog Output Connector	Three 2-wire output channels, CH1, CH2 and CH3, each of which may be configured to give either a 0-20 mA, or a 4-20 mA current loop output or a 0 to 1000 mV voltage signal representing any one of the measured or calculated output parameters selected. Spans for each signal output are separately configurable. Refer to Section 3.2.3.

Table 2 *Rear Panel Controls*

2.5 Rear Panel Connections



These tasks should be undertaken only by competent personnel.



All the connections to the rear panel are electrical connections. Exercise due caution, particularly when connecting to external alarm circuits which could be at high potential.

Connections to the rear panel of the instrument are explained in the following sections.

2.5.1 Power Supply Input

The AC power supply is a push fit into the power input socket as shown in *Figure 3*.



Figure 3 *Power Supply Input*

The method of connection is as follows:

1. Ensure that both ends of the power cable are potential free, i.e. not connected to an AC power supply.
2. Check that the **ON/OFF** switch on the power supply connector is switched to **OFF**.
3. Push the IEC connector firmly into the power input socket.
4. Connect the free end of the power cable to a suitable AC power supply source (voltage range 85 to 264 V AC, 47/63 Hz) and switch on the AC supply. The instrument may then be switched on, as required, by the power **ON/OFF** switch.

2.5.2 Analog Output Connections

The three analog outputs can be configured to represent any of the directly measured or calculated output parameters. They are provided as 2-wire signals from a 6-way connector located on the rear panel of the instrument.

Each of these outputs can be set-up as either a current loop signal (4-20 mA or 0-20 mA) or alternatively, as a 0 to 1 V voltage signal. The configuration of these outputs, i.e. parameter represented, output type (current loop or voltage) and upper/lower span levels are set up via the **SETUP** Menu (refer to Section 3.5.4).

These signals may be used to control external systems. During a **DCC** cycle, and for the hold period following a **DCC** cycle, they are held at the level that they were at immediately prior to the start of **DCC**. When the dew-point measurement is stable, or if the maximum hold period has expired, they are released and will track the selected parameter throughout the measurement cycle.

By default the analog outputs are setup as 4-20 mA current loop, with the following ranges:

Dew point	-40 to +80°C (-40 to +176°F)
Temperature	-50 to +50°C (-58 to +122°F)
% Relative Humidity	0 to 100%

NOTE: The analog outputs are only active during the MEASURE phase. During DCC cycles they will be held at the last measured value.

The three analog output ports connections are made via a single 6-way, push fit connector block as shown in *Figure 4*. All outputs are 2-wire, positive-going signals referenced to a common 0 V line. To differentiate between the outputs it is recommended that a black lead be used for each of the COM (common) lines and a separate color for each of the positive lines.



Figure 4 *Analog Output Connectors*

For each output:

1. Remove the terminal block fitted into the analog output socket.
2. Strip back the wire for the common (black) connection to the **CH1** output, exposing approximately 6mm (0.25") wire insert the wire into the **COM1** terminal way and screw into the block. **Do not overtighten the screw.**
3. Strip back the wire for the signal (e.g. red) connection to the **OP1** output, exposing approximately 6mm (0.25") wire, insert the wire into the **OP1** terminal way and screw into the block. **Do not overtighten the screw.**
4. Repeat operations 1 and 2 for the other analog outputs, selecting a different color wire for the **OP2** and **OP3** outputs.
5. Locate the terminal block over the connector labelled **ANALOG OUTPUTS** and push the terminal block firmly into the connector.

2.5.3 Alarm Output Connections

Two alarm outputs are provided from a terminal block, located on the rear panel of the instrument, as two pairs of potential free, change-over relay contacts. These are designated as a **PROCESS** alarm and a **FAULT** alarm.

The **PROCESS** alarm can be configured to represent any one of the measured or calculated parameters and set-up to operate when a pre-set parameter threshold level is exceeded. By default, the **PROCESS** alarm is set to monitor the dew-point parameter. See section 3.2.4 for further details.

The **FAULT** alarm is a non-configurable alarm which continuously monitors the degree of contamination of the chilled mirror. During normal operational conditions this alarm will be off. If the optics or the mirror contamination exceeds 100% of the film thickness, or if a fault exists on the Pt100, the alarm is triggered and the relay contacts will change state.

This fault is also reported to the status area of the display.

The two alarm output ports are connected to the instrument via a single 6-way, push-fit connector block as shown in *Figure 5*. Each output comprises a 3-wire set of potential free, change-over relay contacts.

Each contact set is labelled **COM** (common 0 V), **N/O** (normally open with respect to **COM**) and **N/C** (normally closed with respect to **COM**).

To differentiate between the alarm output channels it is recommended that a black lead be used for each of the **COM** (common) lines and a separate color for each of the **N/O** and **N/C** lines.



WARNING: Alarm leads MUST be potential free when wiring to the connector block.



Figure 5 *Alarm Output Connectors*

For each output:

1. Strip back the wire for the common (black) connection to the **COM** connector way for the **FAULT** alarm contact set, exposing approximately 6mm (0.25") wire and clamp into the screw block **COM** terminal way. **Do not overtighten the screw.**
2. Strip back the wire for the **N/O** (e.g. green) connection to the **N/O** connector way for the **FAULT** alarm contact set, exposing approximately 6mm (0.25") wire and clamp into the screw block **N/O** terminal way. **Do not overtighten the screw.**
3. Strip back the wire for the **N/C** (e.g. blue) connection to the **N/C** connector way for the **FAULT** alarm contact set, exposing approximately 6mm (0.25") wire and clamp into the screw block **N/C** terminal way. **Do not overtighten the screw.**
4. Repeat operations 1 to 3 for the **PROCESS** alarm contact set, using appropriate colored wires.
5. Locate the terminal block over the connector labelled **ALARMS** and push the terminal block firmly into the connector.

2.5.4 Dew-Point Sensor Connection

The dew-point sensor contains the optical system and the chilled mirror. It is fitted with an M12 connector to allow easy and secure connection to the instrument using the supplied sensor cable.



Figure 6 Dew-Point Sensor Connection

2.5.5 Remote PRT Probe

1. Rotate the body of the PRT probe connector until it locates in the socket labeled **REMOTE TEMPERATURE** (See Figure 7).
2. Push the connector into the socket until it locks. **NOTE: Do not attempt to force it into the socket. If it will not fit in, rotate it until the key locks and it pushes in easily.**
3. To remove the connector, slide the connector's body collar back along its axis, away from the instrument, to release the lock and then gently pull the connector body out of the socket. **NOTE: Do not attempt to pull it out with the cable, make sure that the collar is first released.**



Figure 7 Remote PRT Connection

2.5.6 USB Communications Port Connector

The instrument features a USB port for communication with the Application Software. The appropriate cable will be supplied with the instrument.

1. Check the orientation of the connector and gently push it into the socket labelled **USB** (see *Figure 8*).
2. To remove the connector, pull it out of the socket by holding the connector body. **Do not attempt to remove it from the socket by pulling on the cable.**

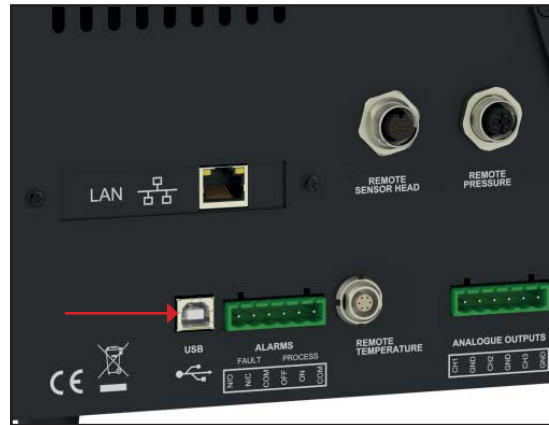

Figure 8 *USB Port Connection*

2.5.7 Ethernet Port (Optional)

The instrument features an optional RJ45 port for communication with the Application Software.

1. Check the orientation of the connector and gently push it into the socket labelled LAN.



Figure 9 *Ethernet Port*

2. To remove the connector, depress the small locking tab on the top and pull it out of the socket by holding the connector body.

For more information on how to configure the Application Software see the section at the end of the manual.

2.5.8 RS232/485 Port (Optional)

The instrument features an optional RS232/485 port for communication with the application software. This is designed to be used with a standard 9-pin D-sub connector.

1. Check the orientation of the connector and gently push it into the socket labelled RS232 or RS485, and tighten the retaining screws.
2. Loosen the retaining screws, and pull the connector out of the socket by holding the connector body.

RS232

Pin 1	N/C
Pin 2	TXD
Pin 3	RXD
Pin 4	N/C
Pin 5	GND
Pin 6	N/C
Pin 7	N/C
Pin 8	N/C
Pin 9	N/C

RS232 Pinout (9-pin female)

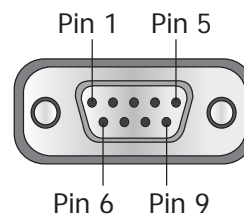

RS485

Pin 1	N/C
Pin 2	N/C
Pin 3	A
Pin 4	N/C
Pin 5	GND
Pin 6	N/C
Pin 7	N/C
Pin 8	B
Pin 9	N/C

RS485 Pinout (9-pin female)

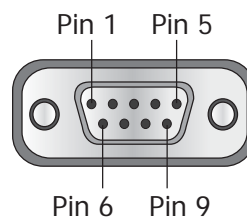

2.5.9 Remote Pressure Transducer (Optional)

1. Rotate the body of the pressure transducer connector until it locates in the socket labelled **PRESSURE TRANSDUCER**.
2. Push the connector into the socket until it locks. **NOTE: Do not attempt to force it into the socket. If it will not fit in, rotate it until the key locks and it pushes in easily.**
3. To remove the connector, slide the connector's body collar back along its axis, away from the instrument, to release the lock and then gently pull the connector body out of its socket. **NOTE: Do not attempt to pull it out with the cable, make sure that the collar is first released.**



Figure 10 Remote Pressure Transducer Connection

3 USER INTERFACE

All measurement results can be read, and all common parameters adjusted, by the 5.7" touch screen display. All functionality available through the touch screen is present when running the Michell Application Software. The Optidew offers 4 possible interfaces to connect to a PC or network:

- USB
- Ethernet (Optional)
- RS232 (Optional)
- RS485 (Optional)

3.1 Main Display

The Optidew features a 5.7" colour touch screen display. When the instrument is switched on, an 'initialising' overlay will be shown while the menu system loads. After the menu system has loaded, the Main Screen will show.

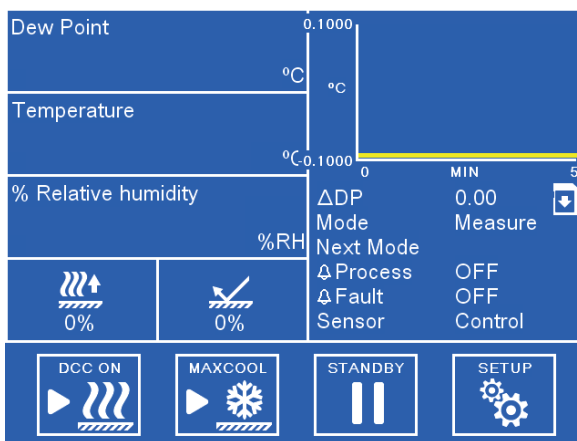

Figure 11 Main Screen

3.1.1 Main Screen

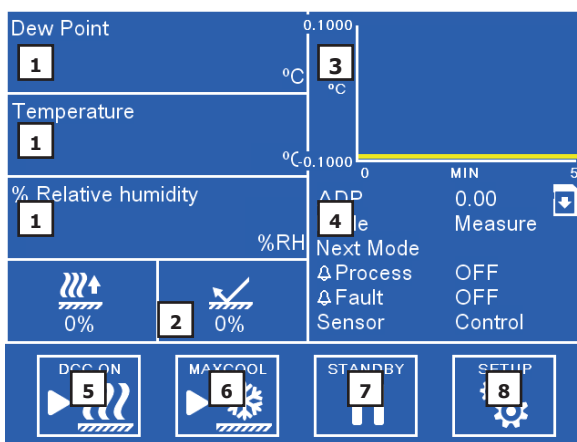

Figure 12 Main Screen Layout

No.	Name	Description
1	Customisable Readouts	Display measured and calculated parameters. See section 3.1.2 for additional information.
2	Sensor Status Display	Displays both thermo-electric cooler (TEC) drive and optical signal condition. See section 3.1.5 for additional information.
3	Trend Graph	Plots measured dew point over time. Time base can be changed in display settings. Touch the readout once to enter full screen mode.
4	Operational Status Display	See section 3.1.4 for a detailed description of this area
5	DCC On/Off	Initiates or cancels a DCC. See section 4.5.1 for an explanation of the DCC function. See section 3.2.1 for DCC setup parameters.
6	Max Cool On/Off	Initiates or cancels a Max Cool. See section 4.5.2 for an explanation of the Max Cool function.
7	Standby/Operate	Toggles between Measure and Standby modes. When switching to Measure mode a DCC will be initiated.
8	Setup	Access the Setup menu. See section 3.1.3 for information on the menu structure and options.

Table 3 *Main Screen Layout*

3.1.2 Customisable Readouts

The three readouts on the Main Screen can be configured by the User to show any of the following parameters:

- Dew Point
- Temperature
- Pressure
- % Relative Humidity
- ppm_v
- % Volume
- g/kg
- g/m³
- Temp-Dew Point

To change a parameter:

1. Touch the readout once to enable parameter selection
2. Touch the left or right arrows to select the parameter to be displayed
3. Touch the centre of the readout to confirm selection

Full Screen Mode

Any of the readouts can be shown in full screen mode by touching and holding the readout.

3.1.3 Menu Structure

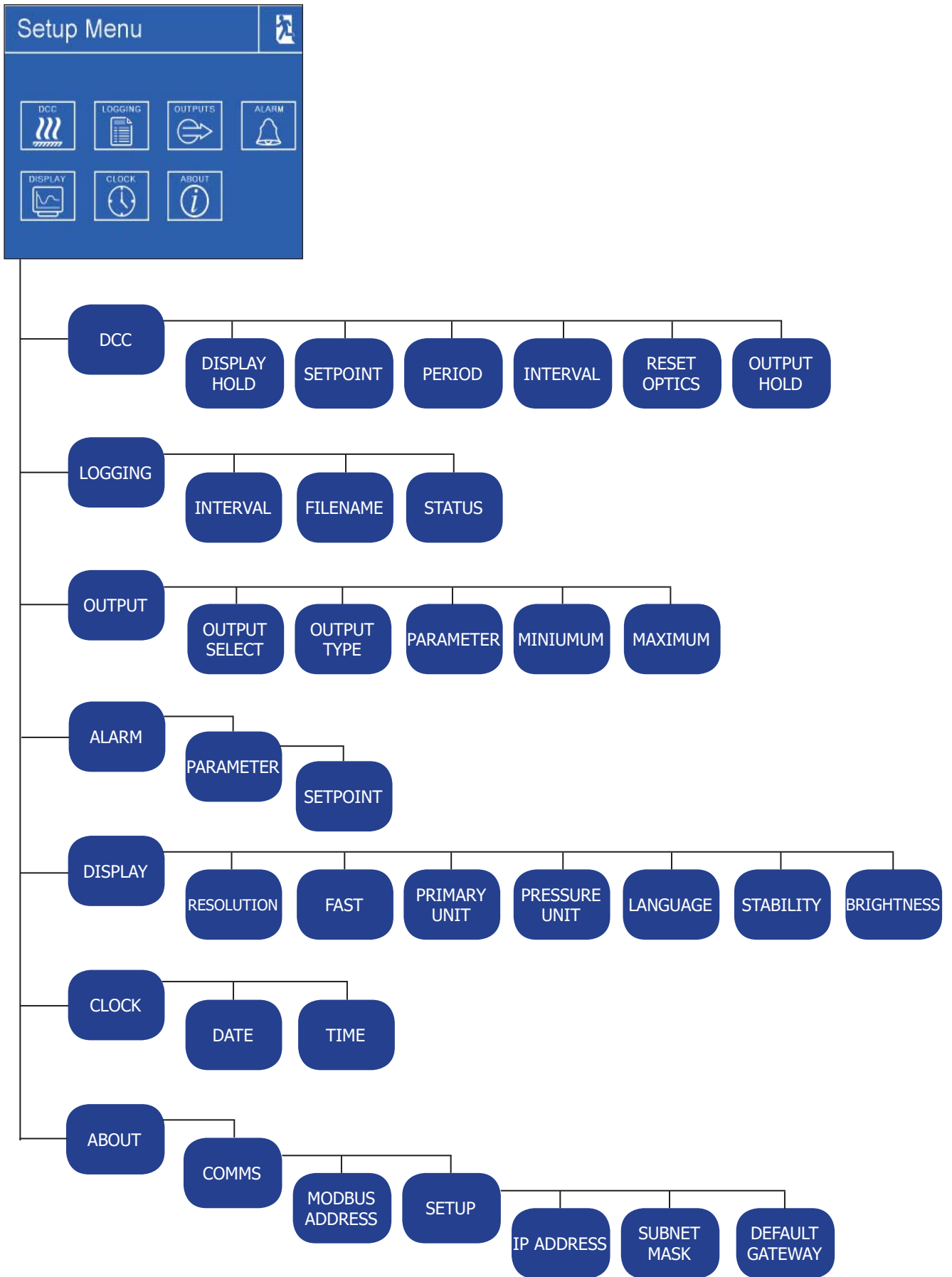

Figure 13 Menu Structure

3.1.4 Operational Status Display

ADP	Shows the total change in measured dew point over the time base of the trend graph	
Mode	Shows current operation mode: Measure, Standby, DCC, FAST, Max Cool, Data Hold	
Next Mode	Counts down until the scheduled mode change, signifying either the start of a DCC or the next measurement period	
Process	Status of Process Alarm For further information on alarm configuration see section 3.2.4.	
Fault	Status of Fault Alarm Indicates there is a fault with the optical system, clean the sensor by following the instructions in section 4.8.	
Sensor	Indicates whether the sensor has established a condensate formation, or if the system is in a transient condition: Heating, Cooling, Control	
Logging		When shown, the S8000 is currently logging data to SD. See section 4.5.6 for further information.

Table 4 Operational Status Display

3.1.5 Sensor Status Display



TEC Drive		Indicates whether the sensor is heating or cooling the mirror: Also indicates the power level applied as a percentage of total possible.
Optical Signal		Indicates the reflectivity of the mirror, and whether this is clean or has a condensate formation. The target is 100% signal level, which indicates the optimal film thickness has been achieved. 0% indicates that the mirror is free of condensate.

Table 5 Sensor Status Display

3.2 Setup Menus

3.2.1 DCC

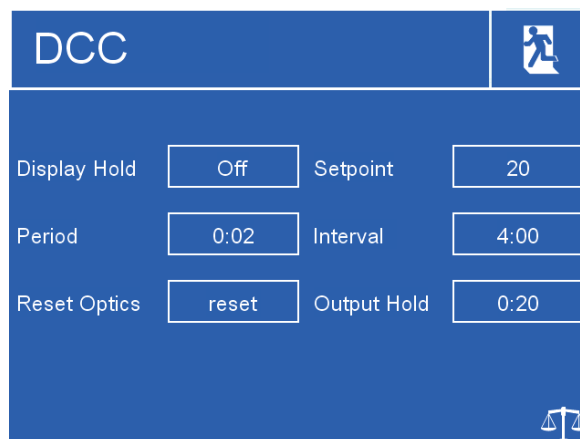

Figure 14 DCC Screen

Display Hold	Also holds measured and calculated values shown on the display throughout the course of Data Hold Available input: Off, On
Setpoint	Mirror heating temperature during DCC, relative to last measured dew point Available input: 10 to 40
Period	Duration of a DCC Available input: 0:01 to 0:59
Interval	Time between automatic DCC cycles Available input: 1 to 99 hours. Set 0 to disable automatic DCCs
Reset Optics	Triggers a reset of the optical signal level on the next DCC cycle
Output Hold	Time to hold the output at the last measured value after finishing a DCC Available input: 4 to 59 minutes

Table 6 DCC Menu

3.2.2 Logging

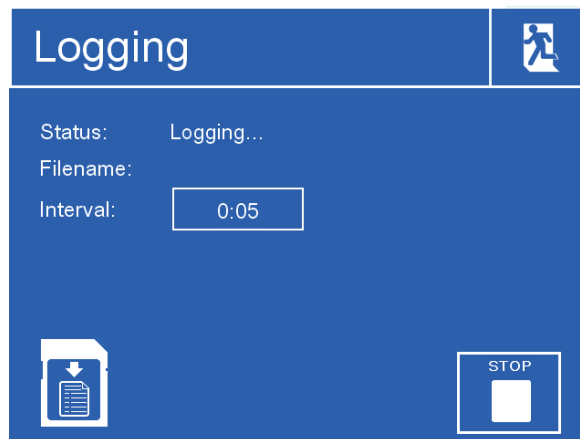

Figure 15 Logging Screen







Interval	Changes the interval at which data is recorded Input format: mm:ss Available input: 0:05 to 10:00	
SD Status Indicator	Indicates status of inserted SD card:	
		No SD card inserted
		Ready to log
		Initialising card
		Error occurred
		SD card is write protected
		Logging
Start/Stop	Begins a new log (file name is generated automatically), or ends a log in progress	

Table 7 Logging Menu

3.2.3 Outputs

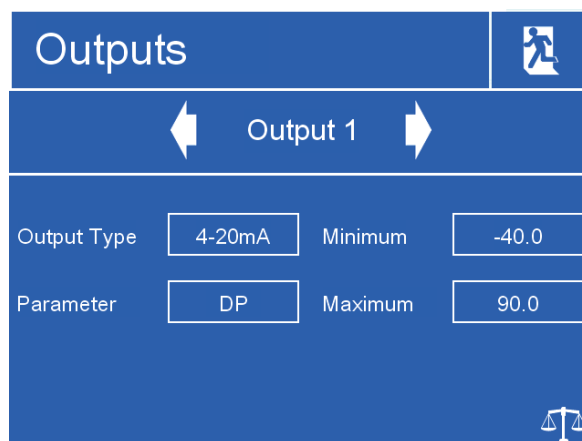

Figure 16 Outputs Screen

Output select	Selects the output to be adjusted Available input: Output 1, 2 or 3
Output type	Selects the type of analogue output signal to use Available input: 4-20mA, 0-20mA, 0-1V
Parameter	The parameter used to control the elected output Available input: DP, Temperature, Pressure, %RH, ppm _v , % Vol, g/kg, g/m ³ , T-DP
Minimum	The minimum output range for the selected parameter Available input: Dependant on parameter
Maximum	The maximum output range for the selected parameter Available input: Dependant on parameter

Table 8 *Outputs Menu*

3.2.4 Alarm

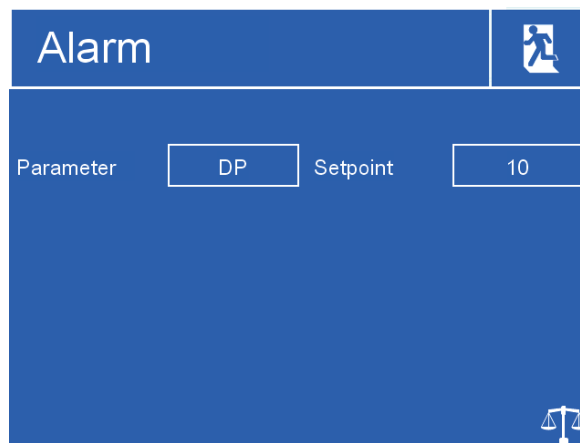

Figure 17 *Alarm Screen*

Parameter	The parameter used to control the alarm Available input: DP, Temperature, Pressure, %RH, ppm _v , % Vol, g/kg, g/m ³ , T-DP
Setpoint	Set point the selected parameter should exceed to trigger the alarm relay to activate Available input: Dependant on parameter

Table 9 *Alarm Menu*

3.2.5 Display

Resolution	Number of decimal places used when displaying parameters on the Main Screen Available input: 1 DP, 2 DP, 3 DP
FAST	Enables or disables the Frost Assurance Technology. See section 4.5.3 for further information. Available input: On, Off
Primary unit	Temperature unit to be used on the display and menus Available input: °C, °F
Pressure unit	Pressure unit to be used on the display and menus Available input: psia, bara, kPa, MPag
Language	Selects the language used for the menu screens. Available input: English, Deutsch, Español, Français, Italiano, Português, USA, Russian, Chinese, Japanese
Stability	Time scale in minutes for the Stability Graph on the Main Screen Input format: hh:mm Available Input: 00:01 to 10:00
Brightness	Screen backlight brightness Available input: 5 to 100%

Table 10 *Display Menu*

3.2.6 Clock

Allows adjustment of current date and time, used for time stamps on logged data.

3.2.7 About (Network Settings)

When the optional Ethernet card is fitted to the S8000, the Network Settings menu is accessible via the About screen.

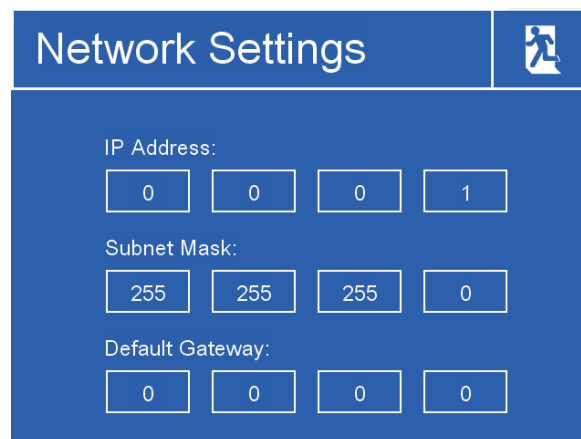

Figure 18 *Network settings*

IP Address	The IP address of the instrument
Subnet Mask	The subnet mask determines what subnet the IP address is on
Default Gateway	The default gateway for network communication

Table 11 *Network Settings*

4 OPERATION

4.1 Operating Cycle

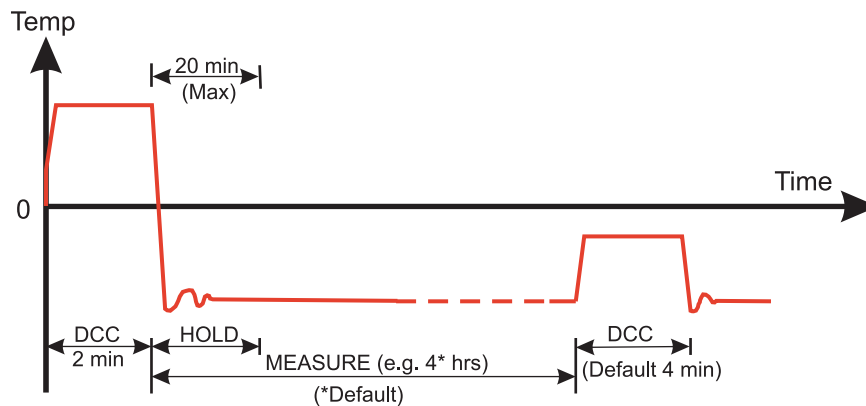

Figure 19 *Typical Operating Cycle*

At initial switch-on, the instrument enters a DCC cycle for 2 minutes. During this time the mirror is heated above the prevailing dew point to ensure that all condensate is driven off the surface of the mirror. The degree of heating is determined by the configuration of the 'Type' and 'Setpoint' parameters in the DCC menu (see section 3.2 for further information).

The mirror is maintained at this temperature for the DCC duration (default 4 minutes) or 2 minutes on switch-on. During the DCC process, Data Hold fixes the analogue outputs at the same value(s) as before DCC commenced. Data Hold typically lasts 4 minutes from the end of a DCC cycle, or until the instrument has reached the dew point. This procedure is in place to prevent any system which is connected to the outputs from receiving a 'false' reading.

After the DCC period has finished, the measurement period commences, during which the control system decreases the mirror temperature until it reaches the dew point. The sensor will take a short amount of time to form a film of condensate and control on the dew point. The length of this stabilization time depends upon the dew point temperature. When the measurement is stable or tracking very slow changes in dew point, the Sensor indicator in the Operational Status display will indicate 'Control'. Note that at dry dew points (below around -20 C) the sensor may display 'Control' when the mirror temperature is still slowly oscillating, always use the trend graph on the display as a secondary indication.

The end of a DCC cycle re-sets the interval counter, meaning that another DCC will start (by default) after 4 hours have elapsed. Once the measurement is stable, Data Hold will release, and the analogue outputs will resume their normal operation. At this point the Status area of the Operational Status display will change to 'Measure'.

4.2 Operating Guide

4.2.1 Description

Once the S8000 has been powered on and has carried out its' initial DCC, it will attempt to find the dew point. In order to measure the dew point a Chilled Mirror hygrometer must control a thin film of condensed water or ice on the mirror.

To initially form the condensate layer the mirror must be cooled past the actual dew or frost point. The control system will then gradually heat the mirror to reduce the thickness of this condensate layer. It typically takes several heating/cooling cycles until the instrument has achieved the optimal film thickness where evaporation and condensation are occurring in equilibrium. This is the true dew/frost point of the sample.

After finding the true dew/point, the control system will continue to maintain the film thickness at a constant level. Any decrease in actual sample dew point will cause evaporation from the condensate film to increase – reducing its thickness and causing the control system to cool the mirror to compensate. Likewise if the dew-point increases then condensation on the mirror will increase, and the control system will heat to compensate.

In extreme cases where the dew point decreases very abruptly, then the condensate will be completely evaporated from the mirror. In these scenarios the system will 'search' for the dew point again by cooling, resulting in cooling past the dew point as described above. A similar situation occurs when the dewpoint increases abruptly, however the condensate film can be lost here by the control system heating to compensate and exceeding the new dew point.

The 'Dew Point' parameter on the Main Screen is a direct measurement of mirror temperature, and only represents the actual sample dew point when the 'Sensor' indicator in the Operational Status Display indicates 'Control'. As described above, 'Control' will be maintained in gradually changing conditions, but step changes will cause the instrument to revert to 'Heating' or 'Cooling' modes.

4.2.2 Operating Practice

There are two basic methods of measuring with the S8000:

- In-situ measurements are made by placing the sensor(s) inside the environment to be measured.
- Extractive measurements are made by installing the sensor into a block within a sample handling system, and flowing the sample outside of the environment to be measured through this system.

Extractive measurements are recommended when the conditions in the environment to be measured are not conducive to making reliable measurements with the product. Examples of such conditional limitations are:

- Excessive flow rate
- Presence of particulates matter
- Presence of entrained liquids
- Excessive sample temperature
- Dew point is beyond depression capability at sample temperature

The basic considerations for each measurement type are as follows:

In-Situ

1. Dew Point Sensor position – will the sensor see an area of the environment that is representative of what you want to measure? For example; you are looking to measure the Relative Humidity of a room which is controlled by an HVAC vent at either end (see figure – Room Measurement Example) you will get very different readings depending on whether the sensor is positioned at point A, point B or point C. Point C provides the most representative sampling point given that it won't be disturbed by the vent or the door.

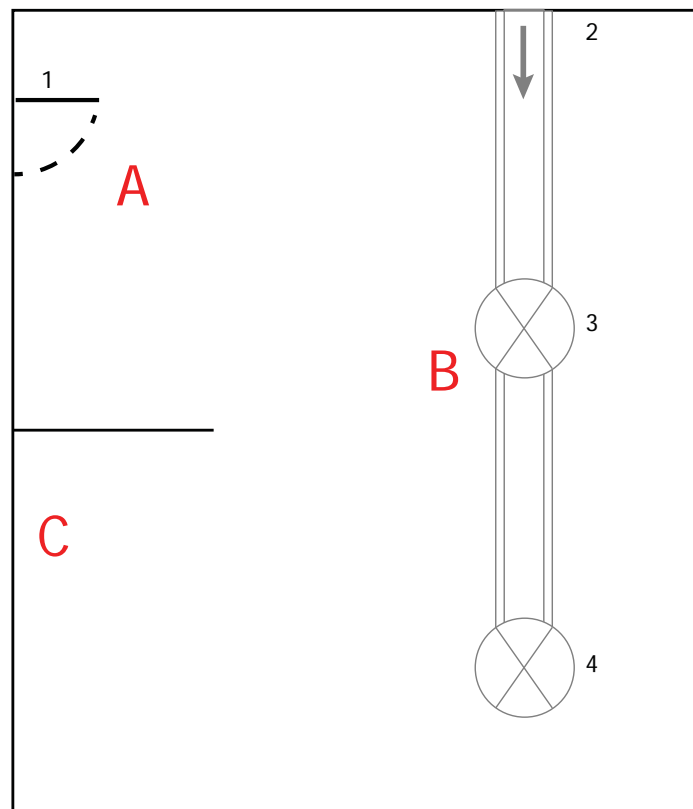

1. Door
2. HVAC Duct, air into room
- 3, 4. Ceiling Vents

Figure 20 Room Measurement Example

2. Gas speed – if you are planning on installing the sensor in a duct, consider how fast the sample gas is moving through it. Excessive flow speed will cause displacement of the condensate layer on the mirror, leading to unstable measurement.
3. If this is the case, then a guard fitted over the sensor can mitigate the effects of excessive gas speed by dissipating the sample throughout its' surface area. An appropriate guard can be purchased from Michell Instruments, contact your local representative.

4. Particulates – particulates passing over the sensor can build up on the mirror over time. This can cause a loss of mirror reflectivity. DCC will compensate for this by taking into account anything on the surface of the mirror when resetting the optical condition, however if the problem becomes too severe, the 'optics warning' symbol will be displayed in the Sensor Status display.
5. Sample temperature – consider the difference between the sample temperature and the dew point temperature. Make sure that the sensor you are using has the cooling capability to make the measurement (see section 4.5.7 for further information).

If the sensor does not have the necessary cooling capability, then you should consider an extractive system so the sample can be cooled prior to measurement.

6. Sample pressure – If you are interested in readings in terms of ppm_v or g/m³ Ensure that the sensor is positioned in an environment of known pressure. You can then either enter this pressure into the S8000 via the Application Software, or connect a pressure sensor directly to the point of measurement (see section 2.5.9).

Extractive

If the sensor will be mounted into a sample conditioning system, then the above points are still of relevance, but the following should also be considered:

1. Extraction point – make sure that the chosen extraction point is representative of the process, i.e. that the sample of interest is flowing past the extraction point, and it is not being pulled from a dead volume.
2. Enclosure and sample line heating – if the sample has a dew point greater than ambient temperature, then all components upstream of the sensor will need to be heated to at least 10°C above the sample dew point to ensure the water remains in vapour phase.

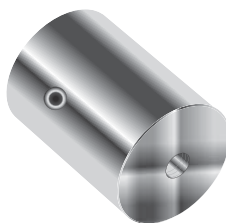

Figure 21 *Sample Block*

4.3 Good Measurement Practice

4.3.1 Sampling Hints

Measurement of moisture content is a complex subject, but does not need to be difficult. This section aims to explain the common mistakes made in measurement situations, the causes of the problem, and how to avoid them. Mistakes and bad practices can cause the measurement to vary from the expectation; therefore a good sampling technique is crucial for accurate and reliable results.

Transpiration and Sampling Materials

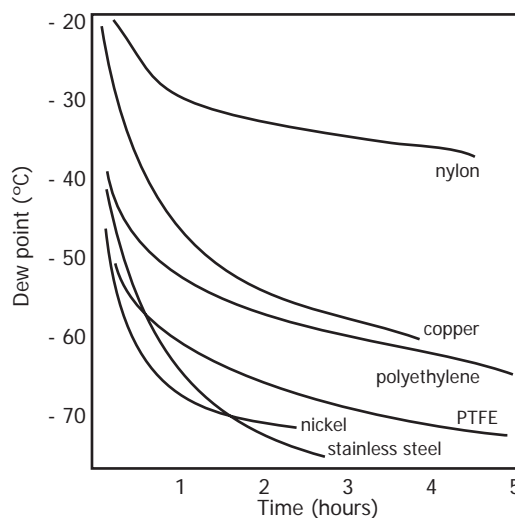

Figure 22 *Material permeability comparison*

All materials are permeable to water vapour, as the water molecule is extremely small compared to the structure of solids, even when compared to the crystalline structure of metals. The graph above shows the dew point inside tubing of different materials when purged with very dry gas, where the exterior of the tubing is in the ambient environment.

Many materials contain moisture as part of their structure, particularly organic materials (natural or synthetic), salts (or anything which contains them) and anything which has small pores. It is important to ensure that the materials used are suitable for the application.

If the partial water vapour pressure exerted on the outside of a compressed air line is higher than on the inside, the atmospheric water vapour will naturally push through the porous medium causing water to migrate into the pressurised air line. This effect is called transpiration.

Adsorption and Desorption

Adsorption is the adhesion of atoms, ions, or molecules from a gas, liquid, or dissolved solid to the surface of a material, creating a film. The rate of adsorption is increased at higher pressures and lower temperatures.

Desorption is the release of a substance from or through the surface of a material. In constant environmental conditions, an adsorbed substance will remain on a surface almost indefinitely. However, as the temperature rises, so does the likelihood of desorption occurring.

In practical terms, as the temperature of the environment fluctuates, water molecules are adsorbed and desorbed from the internal surfaces of the sample tubing, causing small fluctuations in the measured dew point.

Sample Tubing Length

The sample point should always be as close to the critical measurement point as possible, in order to obtain a truly representative measurement. The length of the sample line to the sensor or instrument should be as short as possible. Interconnection points and

valves trap moisture, so using the simplest sampling arrangement possible will reduce the time it takes for the sample system to dry out when purged with dry gas. Over a long tubing run, water will inevitably migrate into any line, and the effects of adsorption and desorption will become more apparent. It is clear from the graph shown above that the best materials to resist transpiration are stainless steel and PTFE.

Trapped Moisture

Dead volumes (areas which are not in a direct flow path) in sample lines, hold onto water molecules which are slowly released into the passing gas; this results in increased purge and response times, and wetter than expected readings. Hygroscopic materials in filters, valves (e.g. rubber from pressure regulators) or any other parts of the system can also trap moisture.

Sample Conditioning

Sample conditioning is often necessary to avoid exposure of sensitive measuring components to liquids and other contaminants which may cause damage or affect the accuracy over time, depending on the measurement technology.

Particulate filters are used for removing dirt, rust, scale and any other solids that may be in a sample stream. For protection against liquids, a coalescing filter should be used. The membrane filter is a more expensive but highly effective alternative to a coalescing filter. It provides protection from liquid droplets, and can even stop flow to the analyzer completely when a large slug of liquid is encountered.

Condensation and Leaks

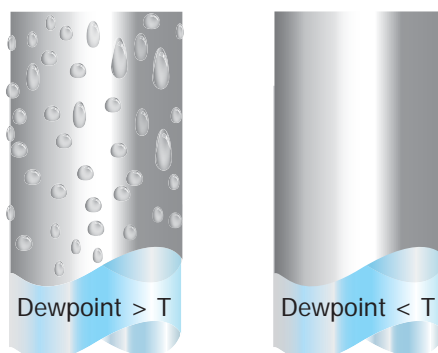

Figure 23 *Formation of condensation*

Maintaining the temperature of the sample system tubing above the dew point of the sample is vital to prevent condensation. Any condensation invalidates the sampling process as it changes the water vapour content of the gas being measured. Condensed liquid can alter the humidity elsewhere by dripping or running to other locations where it may re-evaporate.

The integrity of all connections is also an important consideration, especially when sampling low dew points at an elevated pressure. If a small leak occurs in a high pressure line, gas will leak out but vortices at the leak point and a negative vapour pressure differential will also allow water vapour to contaminate the flow.

Flow Rates

Theoretically flow rate has no direct effect on the measured moisture content, but in practice it can have unanticipated effects on response speed and accuracy. The optimal flow rate varies depending on the measurement technology, and can always be found in the instrument or sensor manual.

An inadequate flow rate can:

- Accentuate adsorption and desorption effects on the gas passing through the sampling system.
- Allow pockets of wet gas to remain undisturbed in a complex sampling system, which will then gradually be released into the sample flow.
- Increase the chance of contamination from back diffusion: ambient air that is wetter than the sample can flow from the exhaust back into the system. A longer exhaust (sometimes called a pigtail) can also help alleviate this problem.
- Slow the response of the sensor to changes in moisture content.

An excessively high flow rate can:

- Introduce back pressure, causing slower response times and unpredictable effects on equipment such as humidity generators.
- Result in a reduction in depression capabilities in chilled mirror instruments by having a cooling effect on the mirror. This is most apparent with gases that have a high thermal conductivity such as hydrogen and helium.



POSSIBLE INJURY! The tubing, valves and other apparatus attached to this instrument must be adequate for the maximum pressure which will be applied, otherwise physical injury to the operator or bystander is possible.



Before disconnecting the instrument from the gas line it is essential to vent the system to atmospheric pressure, otherwise severe injury could result.

4.4 First Time Operation

Before using the instrument, please read through the Installation, Operation and Maintenance sections of this manual. This instruction assumes that all recommendations within these sections have been followed, and that the control unit and sensors are physically installed and all electrical connections complete.

1. Ensure that all sample connections are in good condition, of appropriate materials and are leak-tight
2. Clean the mirror according to the instructions in section 4.8
3. Control the flow rate to within 0.1 to 2Nl/min (1l/min optimal)
4. Power on the instrument

4.5 Operational Functions

4.5.1 DCC Function

Dynamic Contamination Control (DCC) is a system designed to compensate for the loss of measurement accuracy which results from mirror surface contamination.

During the DCC process the mirror is heated to a default temperature of 20°C above the dew point to remove the condensation which has formed during measurement.

The surface finish of this mirror, with the contamination which remains, is used by the optics as a reference point for further measurements. This removes the effect of contamination on accuracy.

After switch-on, the mirror is assumed to be clean, therefore the instrument will only run a DCC for 2 minutes to quickly establish a clean mirror reference point. By default, every subsequent DCC is 4 minutes in duration and will automatically occur every 4 hours.

At certain times it may be desirable to disable the DCC function in order to prevent it from interrupting a measurement cycle, e.g. during a calibration run. This is achieved by setting 'Interval' to '0' in the DCC menu. See section 3.2.1 for further details.

A manual DCC can be initiated or cancelled by touching the DCC button on the Main Screen. The DCC button is context sensitive, i.e. if DCC is on, the Main Screen shows DCC OFF as being selectable. Similarly if DCC is off, DCC ON is shown.

It is possible to change the parameters relating to the DCC cycle on the DCC Setup Screen, refer to Section 3.2.1

4.5.2 MAXCOOL Function

The MAXCOOL function over-rides the dew-point control loop and applies maximum cooling drive to the Peltier heat pump. It can be used to determine:

- What temperature the mirror can be driven down to with reference to the sensor body.
- Whether or not the instrument is controlling at the dew point and whether it is able to reach it. This situation could, for instance, arise when attempting to measure very low dew points where, possibly due to a high ambient temperature, the Peltier heat pump is unable to depress the temperature far enough to reach the dew point.

- Whether the instrument is controlling by switching MAXCOOL on for a short period and then switching back to MEASURE. This will depress the mirror temperature briefly and when it is switched back to MEASURE the control loop should be able to stabilize the mirror temperature at the dew point again.

The MAXCOOL function can be turned on by touching the MAXCOOL button on the Main Screen.

4.5.3 Frost Assurance Technology (FAST)

In carefully controlled laboratory conditions, super-cooled water can exist in temperatures as low as -48°C . However, when using a chilled mirror instrument it only occurs on the mirror at temperatures down to around -30°C .

A gas in equilibrium with ice is capable of supporting a greater quantity of water vapour at a given temperature than a gas in equilibrium with liquid water. This means that a measurement below 0°C taken over water will read approximately 10% lower than the same measurement taken over ice.

Following DCC, the S8000 makes an initial dew point measurement. If the initial measurement is between -3°C and -40°C then the mirror is driven down to below -40°C to ensure the formation of ice on the mirror surface. The instrument then continues operation as normal.

Note that Data Hold is active whenever FAST is active.

For further information, see section 4.5.3.

4.5.4 STANDBY Mode

In STANDBY mode, drive to the Peltier heat pump is disabled. The main use for this feature is during set up (when measurements are not required), i.e. when flow rates are being adjusted and the analogue outputs are being configured.

4.5.5 Parameter Conversions & Pressure Compensation

Many parameters which are calculated by the S8000 require a temperature or pressure reading in addition to dew point to ensure the calculated value is correct. These additional readings can either come from a sensor connected to the S8000, or from a fixed (manual) input. See section 2.5.9 for details on external inputs.

Calculated Parameter	Temperature input required	Pressure input required
%RH	✓	✗
g/m^3	✓	✗
g/kg	✗	✓
ppm_v	✗	✓
%Vol	✗	✓

Table 12 *Calculated Parameters*

If external sensors are used to generate the inputs, then the sensors should be positioned with so that they are making a measurement representative of the environment seen by the dew-point sensor.

4.5.6 Data Logging

The data logging function allows all of the measured parameters to be logged at a user specified interval on the supplied SD card via the SD card slot on the base or side of the instrument. The filename for each log file is generated automatically from the instrument date and time.

Log files are saved in CSV (comma separated value) format. This allows them to be imported easily into Excel or other programs for charting and trend analysis. To set-up data logging refer to Section 3.2.2.

4.5.7 Minimum measurable dew points

The minimum dew point that can be measured is determined by the sensor temperature, and whether the sensor can be maintained at that temperature. The following chart assumes operation in a climatic chamber, where air speed is sufficient to remove any excess heat generated by the sensor.

The minimum measurable dew point also varies depending on the sensor head material. More thermally conductive heads conduct heat away from the mirror and reduce the depression limit. Figure 24 shows the difference between the two types.

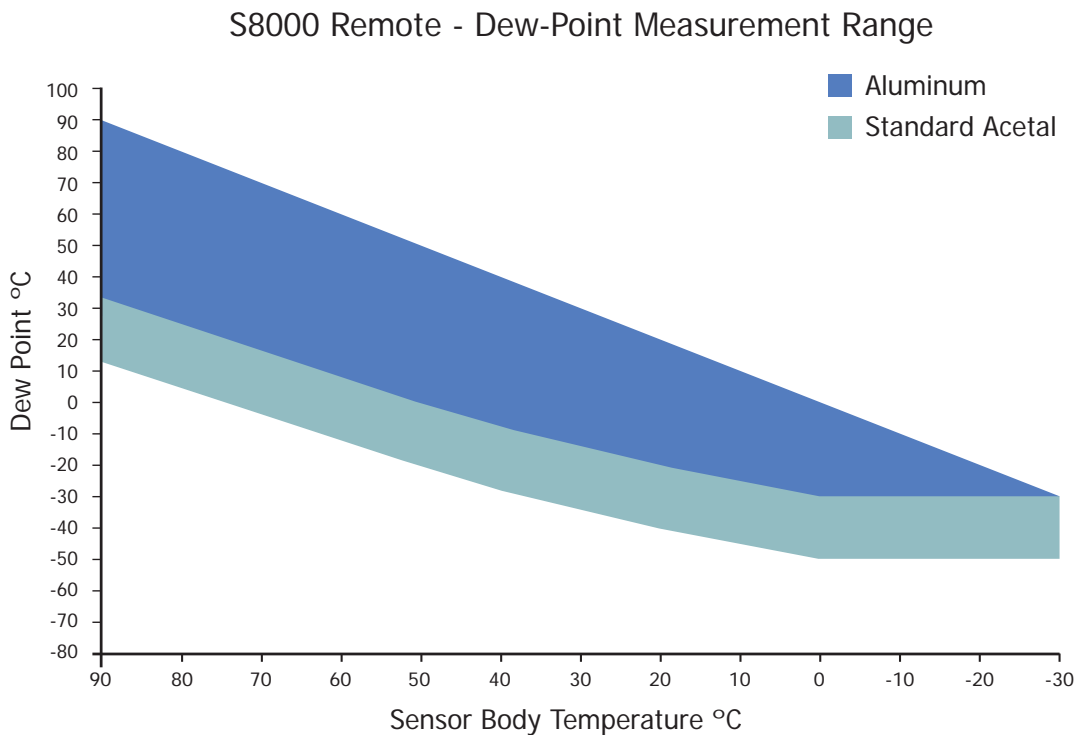

Figure 24 *Minimum Measurable Dew Points*

5 MAINTENANCE

There are few user-serviceable parts on the S8000 Remote. These include cleaning the mirror in the sensor and the removal and replacement of the AC power supply fuse.

5.1 Safety



DANGER
Electric
Shock Risk

This equipment operates from power supply voltages that can be lethal and at pressures (depending upon application) that could cause injury.

Ensure that any test installation meets the standards described in Section 2.3 of this handbook.

Under NO circumstances should the instrument case be removed or the air vents covered or in any way restricted.

Maintenance and repair, other than that described in this section, must only be carried out by trained personnel and the instrument should be returned to the manufacturer for this purpose.

5.2 Fuse Replacement

If the instrument fails to operate after it has been connected to an AC power supply (85 V to 264 V, 47/63 Hz) and switched on, proceed as follows:

1. If the power supply cable is fitted with a fused plug, switch off the power supply, remove the plug, check and, if necessary, replace the fuse. If the instrument still fails to operate, after fitting the fuse and switching the power supply on, proceed as follows (see *Figure 25*).



Figure 25 Power Supply Fuse Replacement

2. Switch the instrument's ON/OFF switch to OFF, isolate the external power supply and remove the IEC power connector from the instrument's power socket.

3. Locate the fuse carrier and pull it out of the connector housing. A small screwdriver inserted under the lip may be useful in order to lever it out.
4. Replace the fuse cartridge. **NOTE: It is essential that a fuse of the correct type and rating is fitted to the instrument (T2.5A 20 x 5mm Ceramic Anti-surge Fuse).**
5. Fit a new fuse cartridge into the fuse carrier and push the fuse carrier back into the power connector housing.
6. Replace the IEC power connector into the power socket, switch on the external power supply and switch on the instrument. Check that the instrument is now operational. If the fuse blows immediately on switch-on either contact the manufacturer or their service agent.
DO NOT ATTEMPT ANY FURTHER SERVICING PROCEDURES

5.3 Sensor Mirror Cleaning

Throughout the life of the instrument, periodic cleaning of the mirror surface and optics window may be required. The frequency of this depends upon operating conditions and the potential in the application for contaminants to be deposited on the mirror. Sensor cleaning is mandatory if the instrument indicates an optics fault.

The cleaning procedure is as follows:

1. Switch off the instrument and remove the sensor from its sample block.
2. Clean the mirror surface and optics window with a cotton bud/Q-Tip soaked in distilled water. If the sensor has been exposed to oil based contamination then use one of the following solvents: methanol, ethanol, or isopropyl alcohol. To avoid damage to the mirror surface do not press too firmly on the cotton bud/Q-Tip when cleaning. Allow the cleaning solvent to fully evaporate.

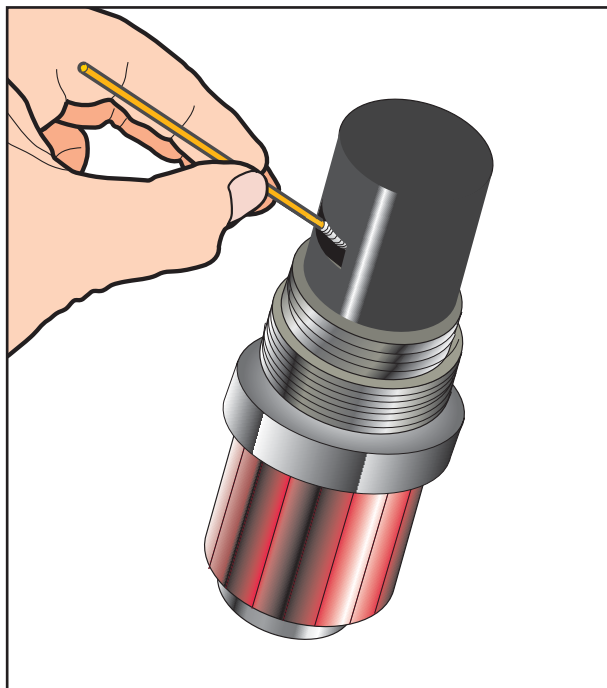

Figure 26 *Sensor Mirror Cleaning*

6 CALIBRATION

6.1 Traceability

The calibration of this instrument is traceable to national standards. For this reason the instrument can only be calibrated in an accredited e.g. NIST or UKAS accredited, standards laboratory.

If these facilities do not exist, the instrument must be returned to the manufacturer, Michell Instruments, or one of their approved agents.

The DCC function can be disabled for calibration purposes (refer to Section 3.2.1).

A calibration certificate bearing a four point calibration is issued with each instrument. If required, an option is available to add further specific calibration points. Contact Michell Instruments for further information (see www.michell.com for contact details).



CERTIFICATE OF CALIBRATION

The under-mentioned item has been calibrated at the following points in the Michell Instruments' Humidity Calibration Laboratory against Test Equipment traceable to the NATIONAL PHYSICAL LABORATORY, Middlesex, United Kingdom and to the NATIONAL INSTITUTE OF STANDARDS & TECHNOLOGY, Gaithersburg, Maryland, USA.

<i>Certificate Number</i>	52045	<i>Ack Number</i>	A26606
<i>Test Date</i>	21 Dec 2011	<i>Test Equipment</i>	Q0332/Q0238/Q0354/Q0383
<i>Instrument Serial Number</i>	131154	<i>Sensor Serial Number</i>	131047
<i>Product Type</i>	S8000 Remote		

<i>Generated Dewpoint °C</i>	<i>Instrument Display °C</i>
-20.1	-20.0
1.0	1.1
18.9	18.8
38.4	38.4

Remote PRT 131155 read 19.25°C at a temperature of 19.33°C

Comments:

NOTE Traceability to National Physical Laboratory is over the range -90°C to +90°C.
 Traceability to National Institute of Standards and Technology is over the range -75°C to +20°C
 Uncertainty of measurement:
 +/- 0.20 @ -20°C DP increasing linearly to +/- 0.40 @ -60°C DP then rising linearly to +/- 0.63 @ -75°C DP
 +/- 0.31 between +20°C DP and +82°C DP
 The uncertainty is based on a standard uncertainty multiplied by a coverage factor k=2, providing a level of confidence of approximately 95 %

Approved Signatory
22 Dec 2011

Michell Instruments Ltd.
www.michell.com

Figure 27 Typical Calibration Certificate

Appendix A

Technical Specifications

Appendix A Technical Specifications

Dew-Point Sensor Performance			
Accuracy	±0.1°C (±0.18°F)		
Reproducibility	±0.05°C (±0.09°F)		
Measurement Technology	Chilled Mirror		
Sensor	2-Stage	High Temp PEEK	Climatic head
Dew-Point Range	–40°Cdp @ sensor temp of +20°C +90°Cdp @ sensor temp of +90°C	–40°Cdp @ sensor temp of +20°C +120°Cdp @ sensor temp of +120°C	–10°Cdp @ sensor temp of +20°C +120°Cdp @ sensor temp of +120°C
Temperature Range	-40 to +90°C (-40 to +194°F)	-40 to +120°C (-40 to +248°F)	-40 to +120°C (-40 to +248°F)
% RH Range	< 0.5 to 100%	< 0.5 to 100%	10 to 100%
Min measured dew point @ 20°C	–40°C	–40°C	–10°C
Mirror Material Options	Gold plated copper (standard), gold stud, Platinum stud**		
Sensor Body Material Options	Acetal (standard), high temperature PEEK, Anodized aluminum**		
Response Speed	1°C/sec (1.8°F/sec) plus settling time		
Operating Pressure	20 barg (290 psig) standard High pressure version: 250 barg (3625 psig) max		
Remote PRT			
Temperature Measurement	4 wire Pt100, 1/10 DIN class B		
Accuracy	±0.1°C (±0.18°F)		
Cable Length	2m (6.6ft) (250m (820ft) max)		
Optional Remote Pressure Sensor			
Measurement Range	0 to 25 bara (0 to 377 psia)		
Accuracy	0.25% Full Scale		
Measurement Units	psia, bara, KPa or MPag		
Pressure Transducer Thread	1/8" NPT		

Monitor	
Resolution	User-selectable to 0.001 dependant on parameter
Measurement Units	°C and °F for dew point and temperature %RH, g/m ³ , g/kg, ppm _v , ppm _w (SF ₆), for calculated humidities
Outputs	Analog: 3 channels, user selectable 4-20 mA, 0-20 mA or 0 to 1 V Digital: Modbus RTU over USB and optionally Modbus RTU over RS232 or RS485, or Modbus TCP over ethernet. Alarm: Two volt free changeover contacts, one process alarm, one fault alarm; 1 A @ 30 V DC
HMI	5.7" LCD with touchscreen
Data Logging	SD Card (512Mb supplied) and USB interface SD Card (FAT-16) - 2Gb max. that allows 24 million logs or 560 days, logging at 2 second intervals
Environmental Conditions	-20 to +50°C (-4 to +122°F)
Power Supply	85 to 264 V AC, 47/63 Hz
Power Consumption	100 VA
Mechanical Specifications	
Dimensions (Instrument)	190 x 255 x 215mm (7.5 x 10.0 x 8.4") h x w x d
Dimensions (Sensor)	ø45 x 128mm with M36 x 1.5-6g mounting thread
Weight	4.2kg (9.26lbs)
Cable Lengths	3, 5 or 10m (9.8, 16.4 or 32.8ft)
General	
Storage Temperature	-40 to +60°C (-40 to +140°F)
Detection System	Single optics detection system with auto adjustment
Calibration	4-point traceable in-house calibration as standard UKAS accredited calibrations optional - please consult Michell

**Recommended for special applications only. Consult Michell Instruments before ordering.

A.1 Dimensions

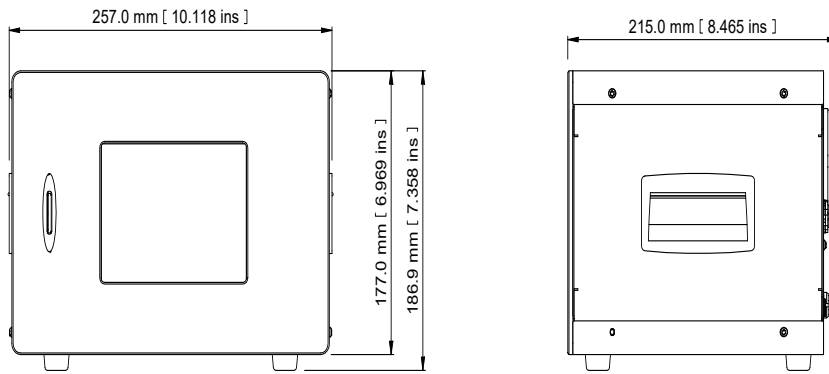

Figure 28 S8000 Remote Dimensions

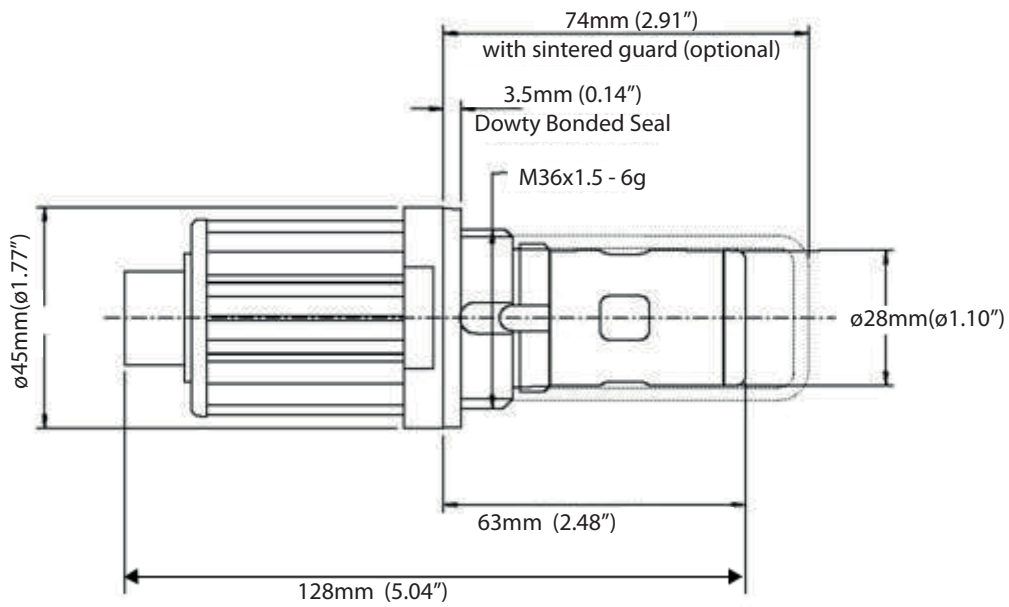

Figure 29 Sensor Dimensions

Appendix B

Quality, Recycling & Warranty Information

Appendix B Quality, Recycling & Warranty Information

Michell Instruments is dedicated to complying to all relevant legislation and directives. Full information can be found on our website at:

www.michell.com/compliance

This page contains information on the following directives:

- ATEX Directive
- Calibration Facilities
- Conflict Minerals
- FCC Statement
- Manufacturing Quality
- Modern Slavery Statement
- Pressure Equipment Directive
- REACH
- RoHS2
- WEEE2
- Recycling Policy
- Warranty and Returns

This information is also available in PDF format.

Appendix C

Analyzer Return Document & Decontamination Declaration

Appendix C Analyzer Return Document & Decontamination Declaration

Decontamination Certificate

IMPORTANT NOTE: Please complete this form prior to this instrument, or any components, leaving your site and being returned to us, or, where applicable, prior to any work being carried out by a Michell engineer at your site.

Instrument			Serial Number	
Warranty Repair?	YES	NO	Original PO #	
Company Name			Contact Name	
Address				
Telephone #			E-mail address	
Reason for Return /Description of Fault:				
Has this equipment been exposed (internally or externally) to any of the following? Please circle (YES/NO) as applicable and provide details below				
Biohazards			YES	NO
Biological agents			YES	NO
Hazardous chemicals			YES	NO
Radioactive substances			YES	NO
Other hazards			YES	NO
Please provide details of any hazardous materials used with this equipment as indicated above (use continuation sheet if necessary)				
Your method of cleaning/decontamination				
Has the equipment been cleaned and decontaminated?			YES	NOT NECESSARY
Michell Instruments will not accept instruments that have been exposed to toxins, radio-activity or bio-hazardous materials. For most applications involving solvents, acidic, basic, flammable or toxic gases a simple purge with dry gas (dew point <-30°C) over 24 hours should be sufficient to decontaminate the unit prior to return. Work will not be carried out on any unit that does not have a completed decontamination declaration.				
Decontamination Declaration				
I declare that the information above is true and complete to the best of my knowledge, and it is safe for Michell personnel to service or repair the returned instrument.				
Name (Print)			Position	
Signature			Date	



Manufacturer: **Michell Instruments Limited**
48 Lancaster Way Business Park
Ely, Cambridgeshire
CB6 3NW. UK.



On behalf of the above named company, I declare that, on the date that the equipment accompanied by this declaration is placed on the market, the equipment conforms with all technical and regulatory requirements of the directives.

S8000 Remote

and complies with all the essential requirements of the EU directives listed below.

2014/30/EU EMC Directive
2014/35/EU Low Voltage Directive (LVD)

and (effective from 22nd July 2017)

2011/65/EU Restriction of Hazardous Substances Directive (RoHS2)
RoHS2 EU Directive 2011/65/EU (Article 3, [24]) states, "*industrial monitoring and control instruments means monitoring and control instruments designed exclusively for industrial or professional use*". (mandatory compliance effective date 22nd July 2017).

and has been designed to be in conformance with the relevant sections of the following standards or other normative documents.

EN61326-1:2006 Electrical equipment for measurement, control and laboratory use – EMC requirements –Class A (emissions) and Industrial Locations (immunity).

EN61010-1:2010 Safety Requirements for Electrical Equipment for Measurement, Control, and Laboratory Use - Part 1: General Requirements

2014/68/EU PE Directive

This product and sample systems & accessories that may be supplied with them do not bear CE marking for the Pressure Equipment Directive, and are supplied in accordance with Article 4, paragraph 3 of 2014/68/EU by using SEP (sound engineering practice) in the design and manufacturer and are provided with adequate instructions for use.



Andrew M.V. Stokes, Technical Director

December 2016

Application Software

The S8000 Remote features a USB interface for communication with the application software. A copy of the application software is supplied on a CD with the instrument.

The application software is also available from the support section of the Michell Instruments' website at: <http://www.michell.com/uk/support/sware-downloads.htm>

1. Installation

1. Extract the contents of the supplied zip file to a suitable location.
2. Close all currently running Windows programs.
3. Launch the installer and follow the on-screen instructions.
4. The installer will ask for an authorization code.
5. Enter **7316-MIL1-8000**.
6. Restart the PC to complete the installation.

2. Establishing Communications

When launching the application software, the Communications Setup screen will be displayed. The following sections explain how to establish communication with the S8000 Remote.

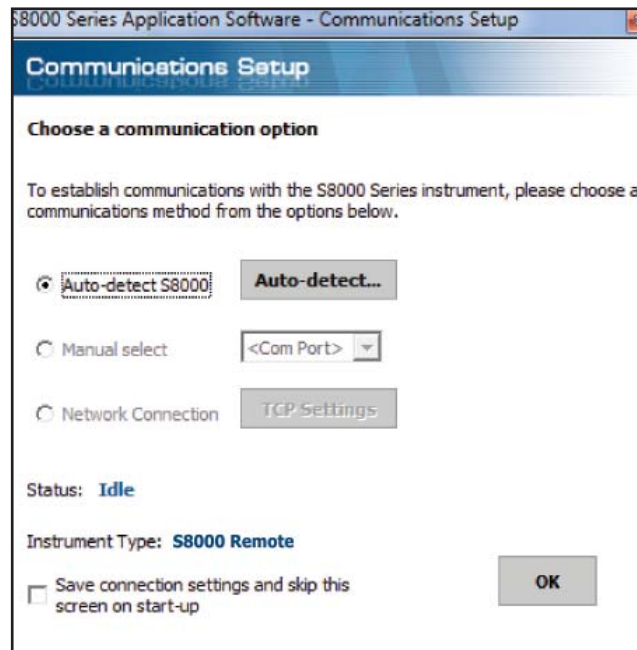

Communications Setup Screen

2.1. USB Communication

1. Connect the S8000 Remote to the PC using the supplied USB cable.
2. Windows will recognize the instrument and automatically install the relevant drivers. If the driver installation has been successful then the Windows Device Manager Screen will list the following driver (see *Figure 28*):

Michell Instruments USB to UART Bridge Controller

3. Launch the application software and choose one of the following types of connection:
4. **Auto Detect** – The application software will attempt to find the correct COM port automatically.
5. **Manual** – Choose the appropriate COM port from the drop down list, as shown in the Windows Device Manager Screen.
6. Click the **OK** button to proceed to the next screen.

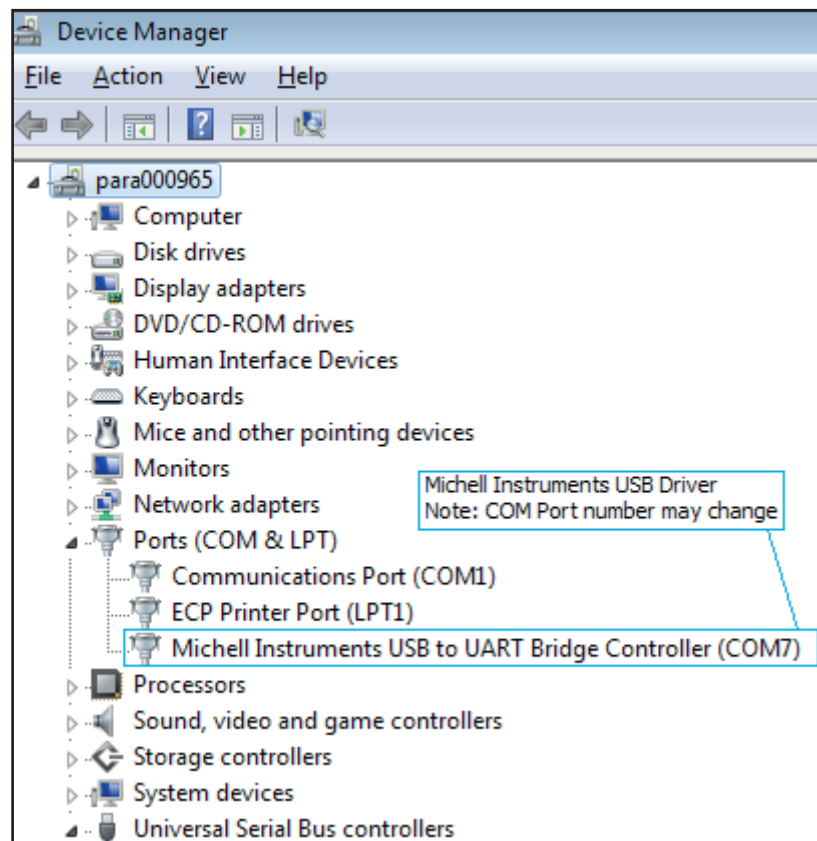

Windows Device Manager Screen

3. Data Acquisition or Edit Variables Mode

Once communication has been established, the Options Screen is displayed.

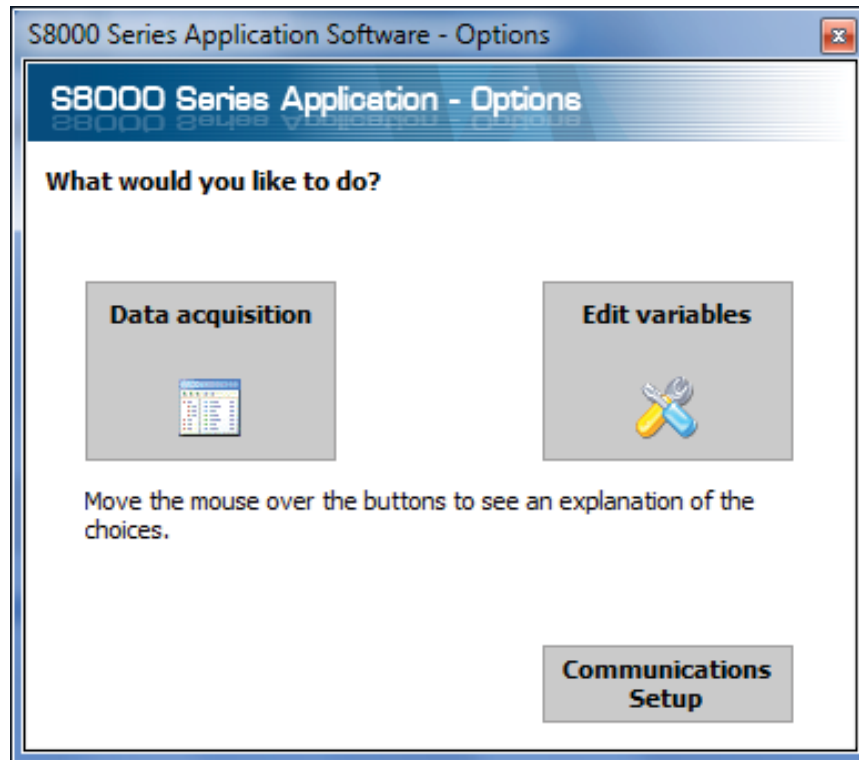

Options Screen

3.1 Data Acquisition

This mode of operation allows all measured instrument parameters to be graphed and logged in real time.

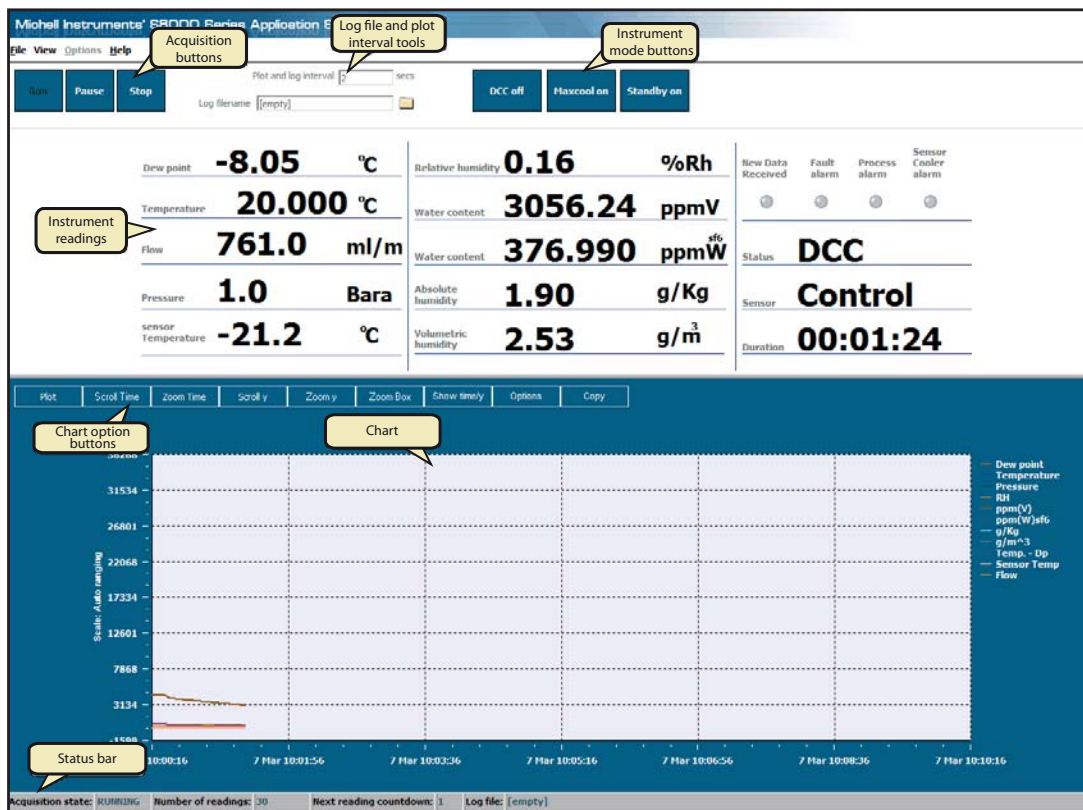

Data Acquisition Screen

Data Acquisition Control Toolbar

Name	Description
Run	Begin data acquisition and logging A filename must be first be selected to enable data logging
Pause	Pause data acquisition
Stop	Stop data acquisition
Plot and log interval	Time in seconds between graph and log file updates
Log filename	Path and filename of the log file Click the small folder icon next to this text box to create a new log file
DCC	Initiate a DCC cycle Refer to Section 3.5.1 for detailed information on the DCC function
Maxcool	Toggle between MAXCOOL and MEASURE mode Refer to Section 3.5.2 for detailed information on the MAXCOOL function
Standby	Toggle between STANDBY and MEASURE mode Refer to Section 3.5.3 for detailed information on the STANDBY function

Data Acquisition Control Description

Instrument Readings and Status

This area displays all measured instrument parameters and shows the status of the Fault, Process and Sensor Cooler Alarms.

Graph Controls

Name	Description
Plot	Automatically advances the graph as new data is acquired
Scroll Time	Dragging the mouse on the graph scrolls along the time axis Drag to the left to scroll forwards Drag to the right to scroll backwards
Zoom Time	Dragging the mouse on the graph changes the scale of the time axis Drag to the left to increase the scale size Drag to the right to decrease the scale size
Scroll Y	Dragging the mouse on the graph scrolls along the Y axis Drag down to scroll up Drag up to scroll down
Zoom Y	Dragging the mouse on the graph changes the scale of the Y axis Drag up to increase the scale size Drag down to decrease the scale size
Zoom Box	Zooms in on both axes in the user selected area
Show time/Y	Select a parameter from the legend on the right hand side of the graph Dragging the mouse along the graph will move the vertical cursor along the time axis The Y value for the selected parameter at the position of the cursor will be displayed above the graph
Options	Displays the chart options window
Copy	Copies the chart to the clipboard as a bitmap file

Graph Control Description

Graph

Plots the parameters selected by the user in the chart options window.

Status Bar

Name	Description
Acquisition state	Indicates whether data acquisition is running, paused or stopped, with the messages RUNNING, PAUSED or IDLE
Number of readings	Number of readings taken since starting the current acquisition session
Next reading countdown	Countdown timer (in seconds), which indicates when the next reading will be taken
Log file	Full path of the log file (if specified)

Status Bar Description

3.2 Variable Edit

The variable edit mode allows the instrument configuration to be changed through the application software. On launch, it will automatically read and display the current values of each of the instrument variables.

NOTE: The variables are not periodically updated on-screen. To obtain up-to-date values, click the Read button.

Editing Variables

To edit a variable, first click on it to highlight it.

If the variable has a fixed list of options, a drop-down arrow will appear in the right-hand column. Choose a new value from the drop-down list provided.

If the variable does not have a fixed list of options, type the new value into the right-hand column text input area.

NOTE: The variable background colour will turn pink to indicate it has been changed on-screen and is pending upload to the instrument.

Click the Write button to upload changed values to the instrument.

NOTE: Variable values and formatting are checked by the application software before they are uploaded to the instrument.

A message box will report any errors found.

Once a modified value has been written to the instrument, the background colour will return to white.

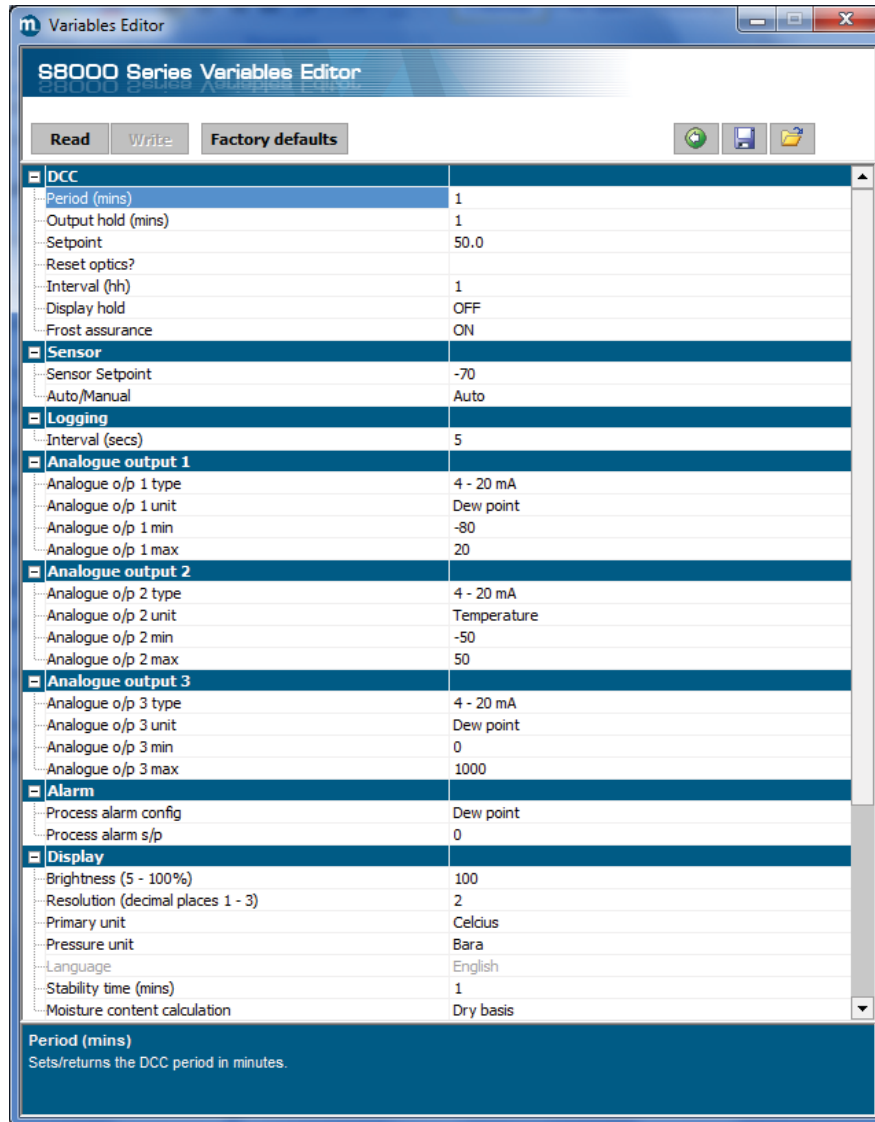

S8000 Series Variables Editor Screen



<http://www.michell.com>