



# MONITORING, DATA LOGGING AND CONTROL SYSTEM MS6D, MS6R

## Instruction Manual Basic Part

**Copyright:** COMET System, Ltd. It is prohibited to copy and edit this instruction manual and make any changes at all without explicit agreement of COMET System, Ltd. All rights reserved.

COMET System, Ltd makes constant development and improvement of all its products. That is why it reserves the right to make any technical changes on the device/product without previous notice.

**CONTENT:**

page

INTRODUCTION .....	3
1. GENERAL SAFETY PRECAUTIONS .....	6
2. WIZARD for INSTALLATION and CONFIGURATION of DATA LOGGER.....	6
3. RULES for MOUNTING and CONNECTION of DATA LOGGER .....	8
3.1. Mechanical location of data logger and the way of cable routing.....	8
3.2. Data logger interface connectors .....	13
3.3. Mounting and connection of output relays module MP018 and MP050 .....	18
3.4. Mounting and connection of external terminal with display.....	19
3.5. Connection of data logger to the computer .....	19
3.6. Connection of data logger with support of SMS messaging .....	21
3.7. Connection of data logger to power .....	21
4. CONTROL and INDICATION COMPONENTS of DATA LOGGER.....	22
5. USER PROGRAM FOR DATA LOGGER.....	28
5.1. Program features.....	28
5.2. Installation of program .....	28
5.3. Setting of communication with data logger .....	28
5.4. Basic items in menu program .....	29
6. DESCRIPTION of CONFIGURATION and DATA LOGGER MODES .....	30
6.1. Bookmark <i>Common</i> .....	30
6.2. Bookmark <i>Communication</i> .....	30
6.3. Bookmark <i>Profile</i> .....	32
6.4. Bookmark <i>Ch.. Identity &amp; Calculations</i> .....	33
6.5. Bookmark <i>Ch.. Measuring &amp; recording</i> .....	33
6.6. Bookmark <i>Ch..Conditions</i> .....	36
6.7. Bookmark <i>Ch..Alarms and indication</i> .....	41
7. APPLICATION NOTES.....	42
7.1. <i>Processes and how to work with</i> .....	42
7.2. <i>SMS message and how to work with</i> .....	42
7.3. <i>Possibilities of setting Logging interval</i> .....	43
7.4. <i>Identification of person, who deactivated alarm</i> .....	43
7.5. <i>Way of entering PIN code from data logger keyboard</i> .....	43
7.6. <i>Sharing of Display mode on several computers together with automatic storing of data on network</i> .....	43
7.7. <i>How to ensure alarm report, in case of power failure</i> .....	44
7.8. <i>Back-up of data logger configuration and its restoring</i> .....	44
7.9. <i>How to set variable condition limit according to measured value on other channel?</i> .....	44
7.10. <i>Can be confirmation of alarm signalization applied to acoustic alarm only?</i> .....	44
7.11. <i>It is possible to force confirmation of alarm signalization again after some time?</i> .....	44
7.12. <i>What is it "latched alarms"?</i> .....	44
7.13. <i>Other possibilities in data logger configuration</i> .....	45
7.14. <i>What to do if data logger does not work</i> .....	45
7.15. <i>Self test error</i> .....	45
7.16. <i>Problems with correct measurement</i> .....	45
7.17. <i>Problems in communication with computer</i> .....	45
8. RECOMMENDATION FOR OPERATION AND MAINTENANCE.....	46
9. TECHNICAL DESCRIPTION AND PARAMETERS OF DATA LOGGER .....	48

Note: Manual Appendixes are available in electronic pdf format at [www.cometsystem.com](http://www.cometsystem.com) .

## INTRODUCTION

Data loggers are designed for measurement, record, evaluation and consequent processing of input electrical signals, characterized by relatively slow changes (>1s). Together with proper transmitters and transducers are suitable for monitoring of physical values.

Device enables:

- to measure and process 1 to 16 input signals
- to acquire autonomous time record of measured values
- create alarm states
- to perform other actions based on created alarms (audible, visual indication, controlling of relay outputs, sending SMS message, controlling of telephone dialer, sending of messages via several protocols of the Ethernet interface etc.)
- to monitor on-line measured values and states

The basic model is data logger MS6D. Data loggers MS6R are designed for 19'' rack mounting (one rack unit 1U) or for desktop use.

*Drawing (MS6D):*

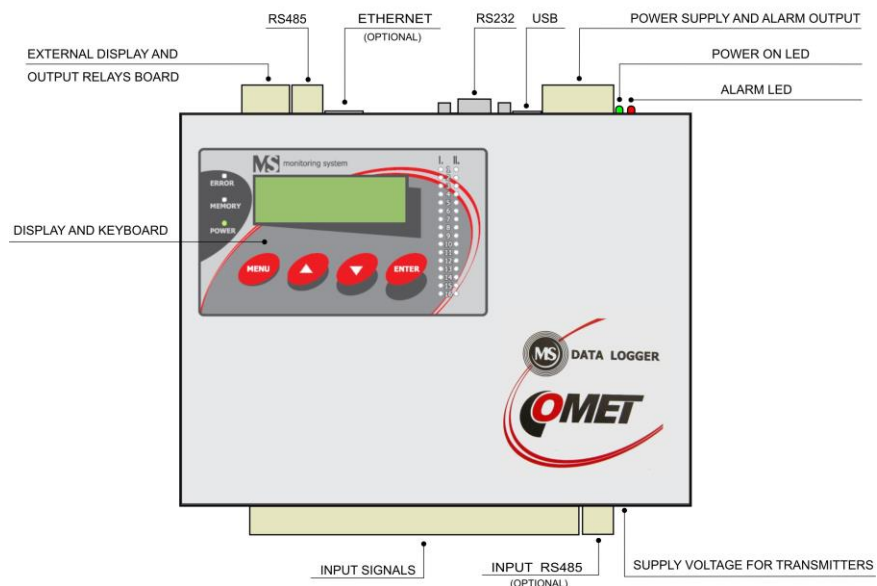

*Drawing of MS6R with MP041 feet, positions of connection terminals are analogical with MS6D:*



*Items marked Accessory are not included in delivery and it is necessary to order separately.*

Drawing of MS6-Rack:

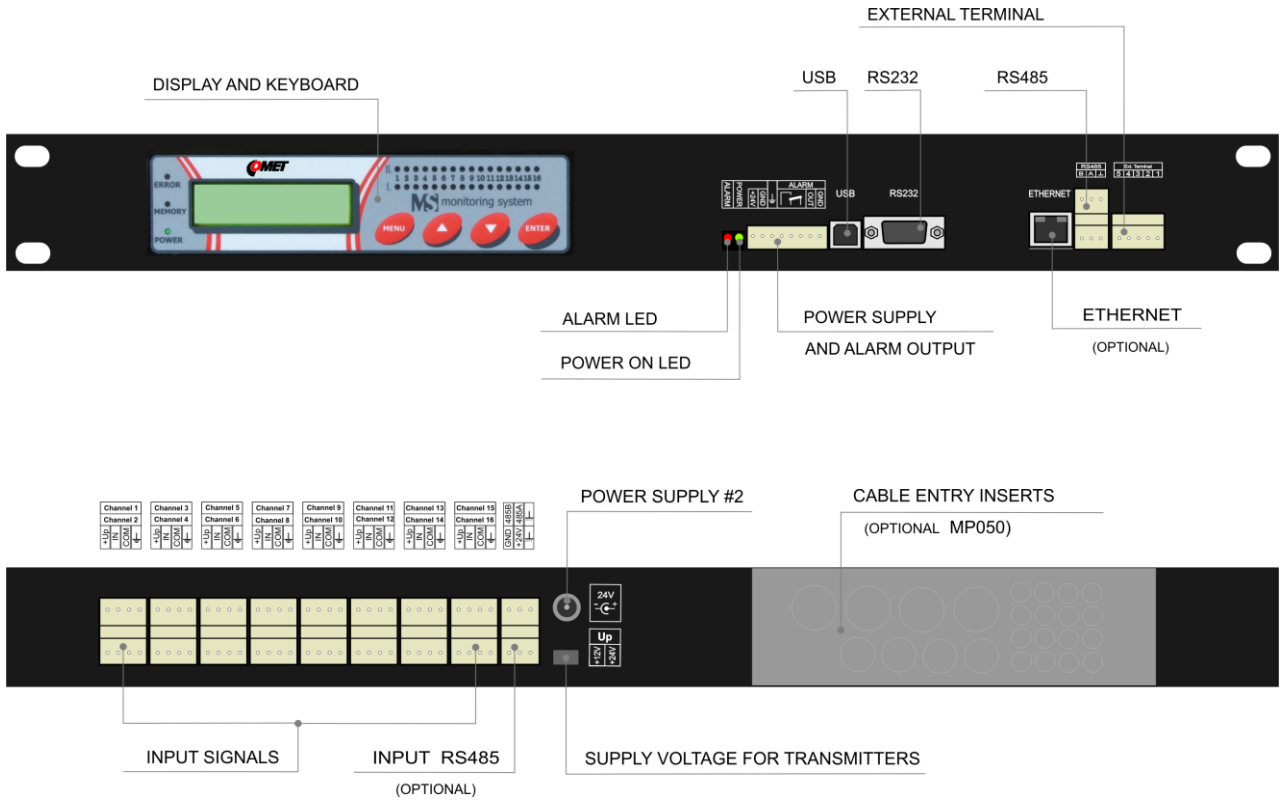

Drawing of MS6-Rack with output relays module MP050:

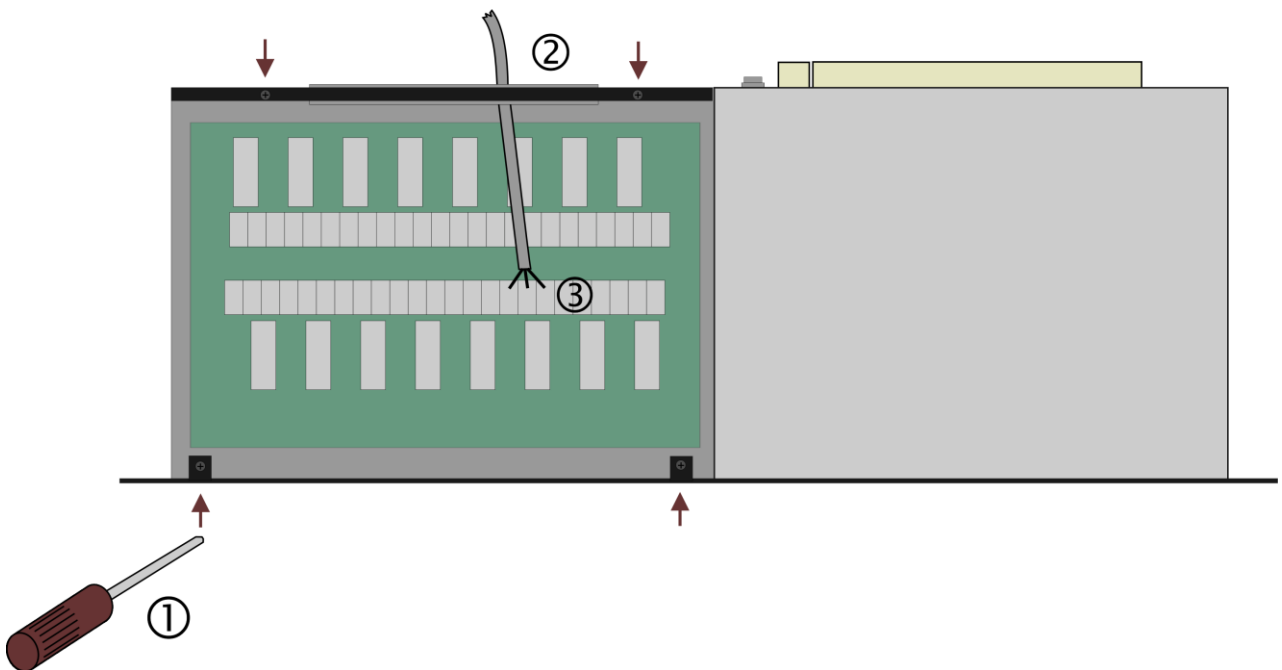

Architecture of measuring system with data logger MS6D, MS6R:

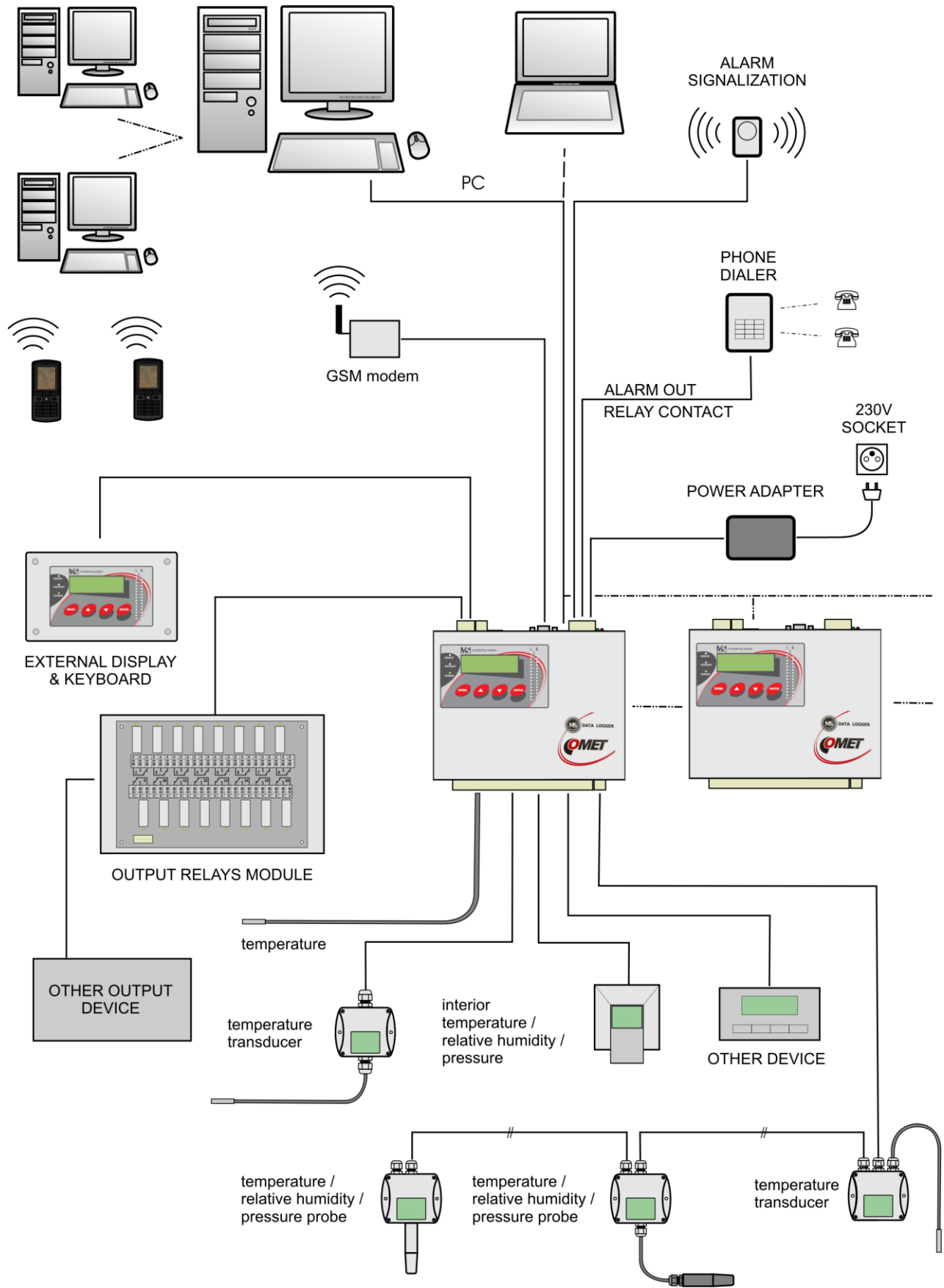

## **1. GENERAL SAFETY PRECAUTIONS**



The following list of precautions serves to reduce risk of injury or damage of described instrument. To prevent injuries, use instrument accordingly with rules in this manual.

- **Follow rules specified in part Not allowed manipulations and notice**
- **Installation and service need to be performed only by qualified person.**
- **Use suitable power source.** Use only source with power voltage recommended by the manufacturer and approved in accordance with proper standards. Pay attention, the source has undamaged cables or cover.
- **Connect and disconnect correctly.** Do not connect and disconnect cables, if device is under electrical voltage.
- **Do not use instrument without covers.** Do not remove covers.
- **Do not use instrument, if it does not work correctly.** If you mean instrument does not correctly, let it check by qualified service person.
- Do not use instrument in environment with danger of explosion.

## **2. WIZARD for INSTALLATION and CONFIGURATION of DATA LOGGER**

### **2.1. Mounting of data logger and its accessory**

- **Select suitable location for placing data logger** – pay attention to parameters of ambient environment, minimize the number of cables, avoid sources of interference
- **Mounting of sensors and routing of cables** – pay attention to rules of theirs installation, use recommended working positions, avoid devices and distribution of power electricity
- **Check proper connection** – before first switching on. If data logger controls other actuating devices of regulation, it is recommended to put them out of operation before configuration of data logger.

*Basic rules for mounting of data logger are described in chapter RULES for MOUNTING and CONNECTION DATA LOGGER. Detailed information on different connections to the PC are described in Appendix No. 3 in electronic version.*

### **2.2. Basic activation of data logger**

- **Connection of data logger to power** - connect data logger to power and visually check its function (indication of power, optionally the display and keyboard)
- **Installation of software** - install user program to the PC (see part PROGRAM for DATA LOGGER)

**Configuration of data logger communication with computer** – in user SW in part Configuration-Setting of communication configure and test the data logger connection to computer. Basic description of Setting of communication interface is in chapter RULES for MOUNTING and CONNECTION of DATA LOGGER. Detailed description is in Appendix No. 3 in pdf format.

*Program enables to work simultaneously with several data loggers, that are connected to the computer in different ways.*

### **2.3. Configuration of data logger** – read and change the data logger configuration by means of the SW in part Configuration – Configuration of data logger (icon i). Detailed description of data logger configuration is in part DESCRIPTION of CONFIGURATION and MODES of DATA LOGGER.

- set data logger Name, Date and Time in data logger
- select suitable *Type and range* of input channel corresponding with character of connected input signals
- assign names to each measured point and optimize the display for your requirements (signal conversions, decimal point position etc.)
- switch on each input channel needed and set record function:
  - on channels where recorded value with fixed interval is required, use Continuous record with fixed interval.
  - if record with fixed interval only under certain conditions is required, use Conditional record.
  - if only values and time under defined conditions are required, use Sampled record
  - each type of record can be limited in time
  - different record modes can be combined
- if needed set alarm functions
  - first define conditions for consequent actions
  - assign to each alarm conditions for creation of alarm
  - assign to each alarm actions to be performed in alarm creation (lightening of LED diode on data logger panel, activation of ALARM OUT output, activation of audible indication, sending SMS message, sending e-mail etc.)
  - maximum four conditions and two different alarm actions on one channel can be defined; if there is a need for one channel to link several alarms (maximum four), it is enabled to use available alarms from different channels
  - activity of output ALARM-OUT can be cancel by the user directly from data logger or remotely, at the same time it is possible to record it (including information on way of canceling)
  - changes of state for each alarms can be recorded separately
- if there is a need during data logger operation to describe from its keyboard parts of record with predefined notes, it is enabled by means of Processes.
- MS6 data logger does not enable to switch different configurations from the instrument keyboard during operation. To switch to different configuration use the PC program
- if it is required to secure data transfer and access to data logger and program functions, system of passwords and access rights can be used

*Read chapter APPLICATION NOTES, where detailed information on several applications are described.*

## **2.4. Usual work with data logger**

- reading, viewing, archiving and print/export recorded data from selected data logger or from file on disk
- on-line viewing of measured values – Display mode, enables to watch simultaneously all connected data loggers. This mode can be shared simultaneously on several computers in the network
- performance of actions based on created alarm states

Instructions for regular check and maintenance of data logger are specified in part RECOMMENDATIONS for OPERATION and MAINTENANCE.

### 3. RULES for MOUNTING and CONNECTION of DATA LOGGER

#### 3.1. Mechanical location of data logger and the way of cable routing

Location of data logger must match the operating conditions and not allowed manipulations.

Working position of data logger:

- data logger MS6D or MS6R lies on horizontal nonflammable surface <sup>1)</sup>
- data logger MS6D is fixed<sup>2)</sup> by means of mounting consoles on the wall from nonflammable material or at low current switchboard – working position is with input connectors downward

The way of mounting of consoles to data logger and mounting holes dimensions:

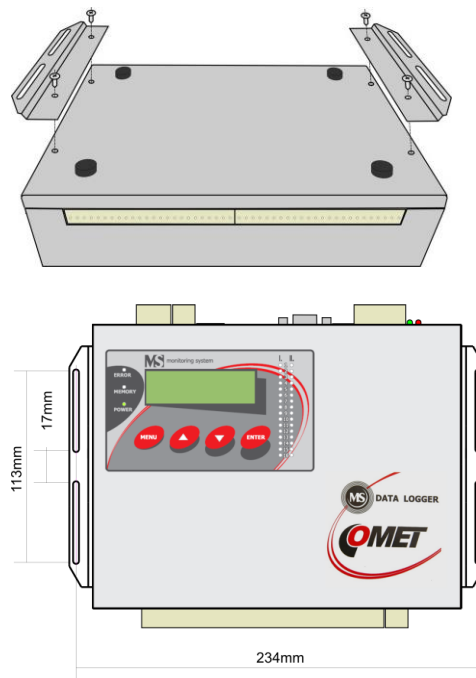

- data logger MS6D is fixed<sup>2)</sup> by means of the holder on DIN rail at low current switchboard - working position is with input connectors downward

The way of mounting the holder to data logger:

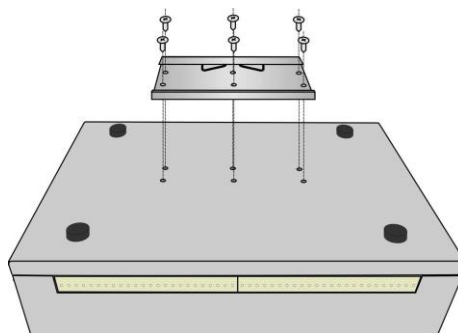

- data logger MS6R is mounted to 19'' rack<sup>1)</sup>

Notes:

<sup>1)</sup> horizontal working position for data loggers with thermocouple inputs is not suitable

<sup>2)</sup> using of the original screws is required (longer screws can damage device)!



*Mechanical drawing of MS6R data logger with mounting brackets for 19'' rack:*

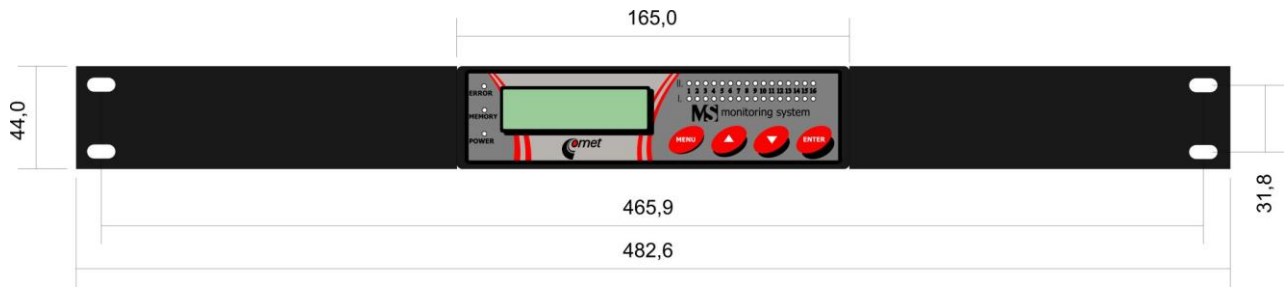

*Mechanical drawing of MS6D data logger (without cables and connectors):*

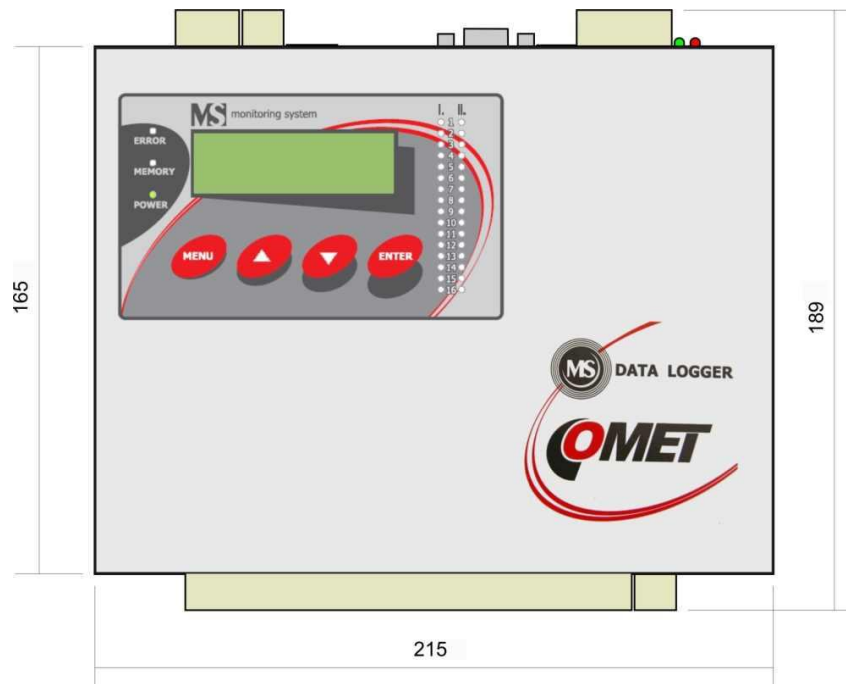

Connection terminals and connectors can be protected by magnetically fixed side covers MP027.

Mechanical drawing of MS6-Rack data logger:

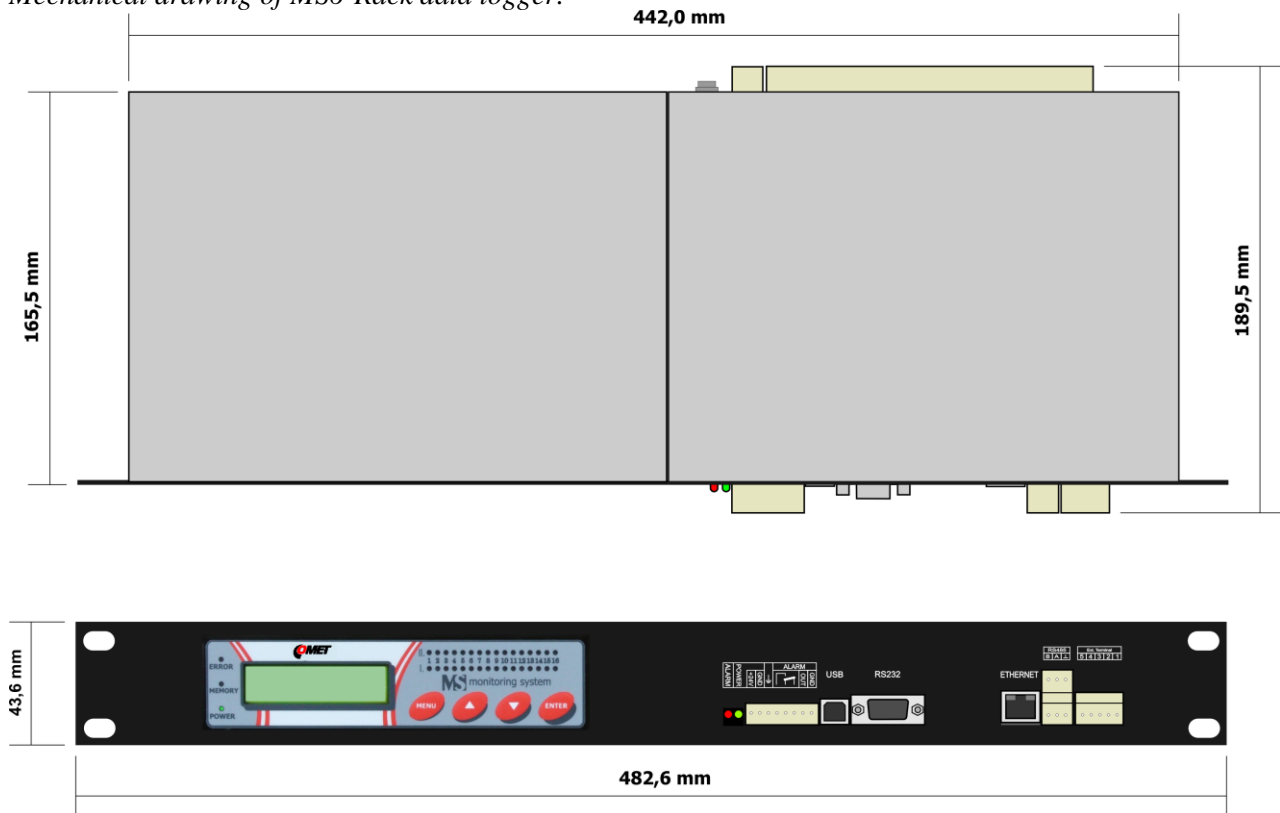

**Recommendations for mounting:**



Use original included screws to mount side brackets or DIN rail holder. Using longer screws can cause reduction of insulation distance between screws and printed circuit board or short circuits. This can cause system functionality and safety of the users!

- **do not mount data logger near sources of interference** (data logger must not be mounted directly to power switchboard nor to its nearness. Also do not mount data logger near power contactors, motors, frequency converters and other sources of strong interference).

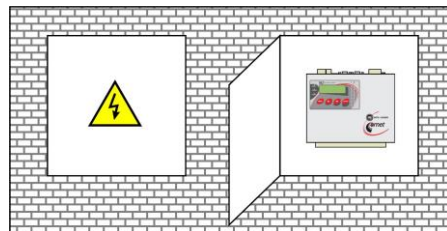
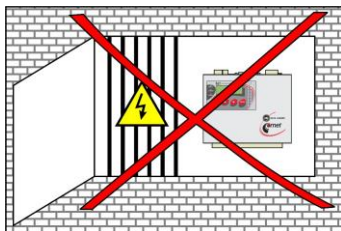

- In cable routing follow rules of standards for installation of low current distribution (EN 50174-2), especially it is necessary to pay attention to avoid electromagnetic interference intrusion to the leads, transmitters, transducers and sensors. Do not locate cabling near sources of interference.

- **Do not use leads in parallel with power distribution network leads**

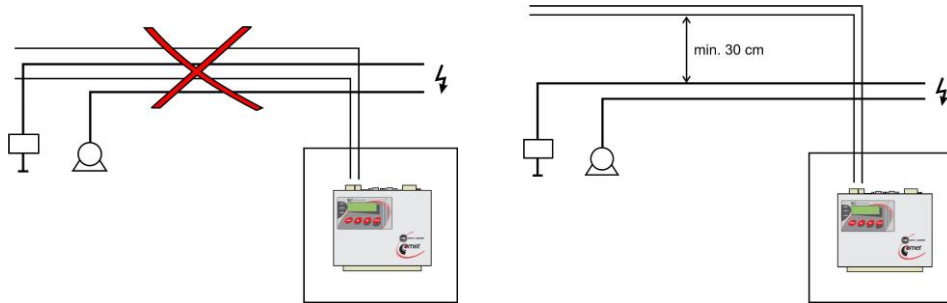

- **Do not use outdoor leads without corresponding protection against effects of static electricity**
- **if not necessary, do not connect system with other circuitry**
- **fundamentally use shielded cables** - e.g. SYKFY n pairs x 0.5, shielding at data logger side connect properly
- **do not create earth loops** - it concerns both measuring circuits and cable shielding.

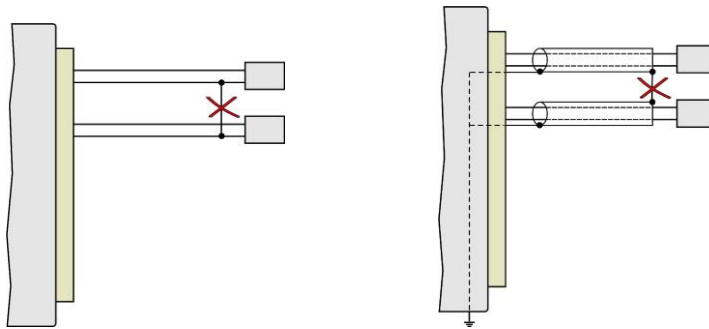

- **do not create hidden earth loops** - do not connect cable shielding at end device side, if these devices do not have terminal designed for shielding. Shielding must not be connected to outer metal parts of the device nor with other devices. Do not use shielding as a signal lead.

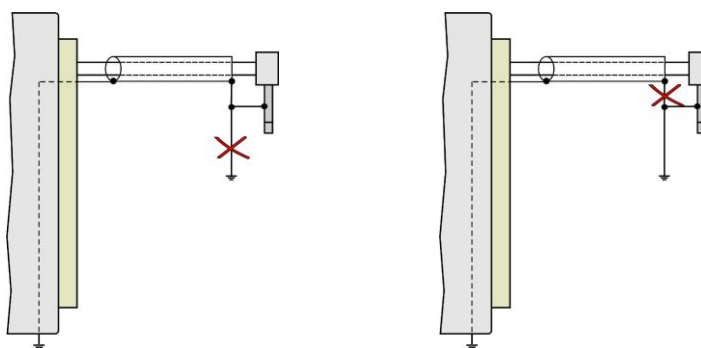

- **Do not use common leads for several channels**

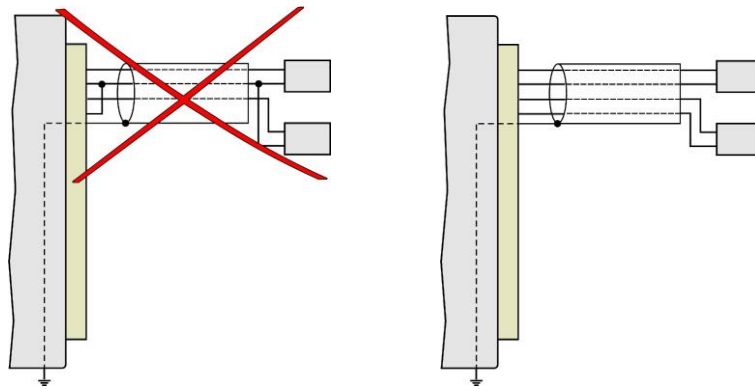

- **It is recommended to earth data logger at one point** – there is a special terminal on power terminal. This earthing will work correctly, if system would not be grounded at other point at the same time.

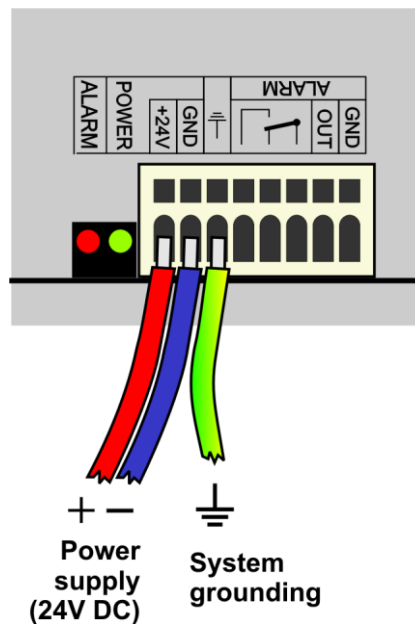

*If system is not grounded properly, it is a danger of state, when system floats on variable potential against all other circuitry. It can cause communication dropouts, occasional resets and in extreme case damage of some peripherals. Especially when using pulse power sources (e.g. A1940) it is strongly recommended to ground the system.*

### 3.2. Data logger interface connectors

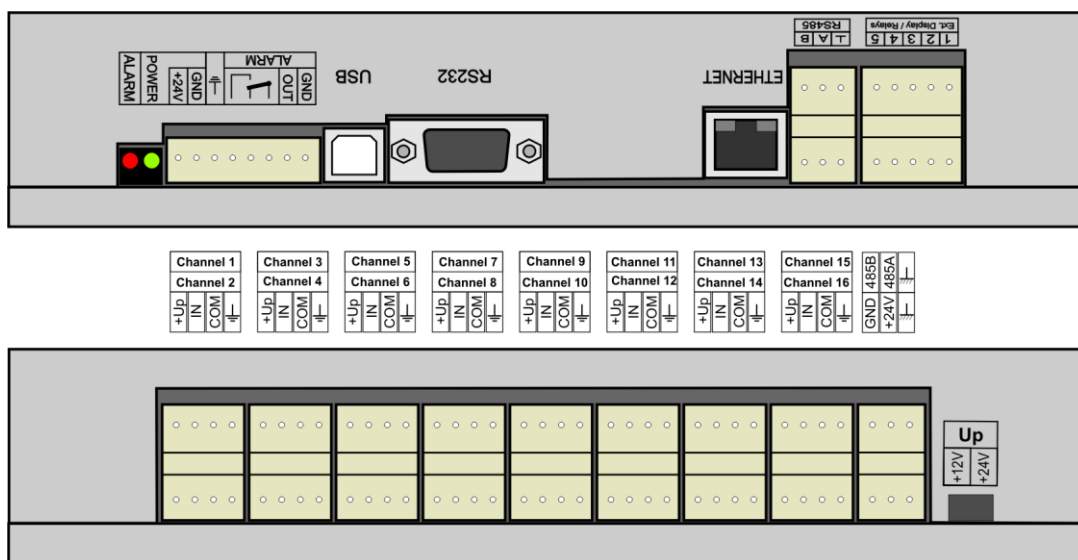

#### Connectors

Each signal is connected to self-locking terminal WAGO located on the side of the case. Insert flat-bladed screwdriver to rectangle terminal hole and push screwdriver towards away from you - contact is released. Connect wire to released terminal (circular hole behind the rectangular one) and close the terminal by removing the screwdriver.

*Notice: The entire input terminal block is possible to remove from data logger by pulling it up from the connector.*

*Connection of leads:*

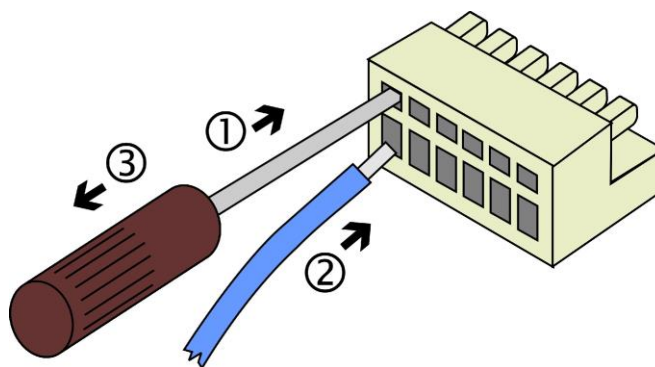

Terminals of input channels are keyed to prevent undesirable mismatch between channels.

## Simplified wiring of input circuitry

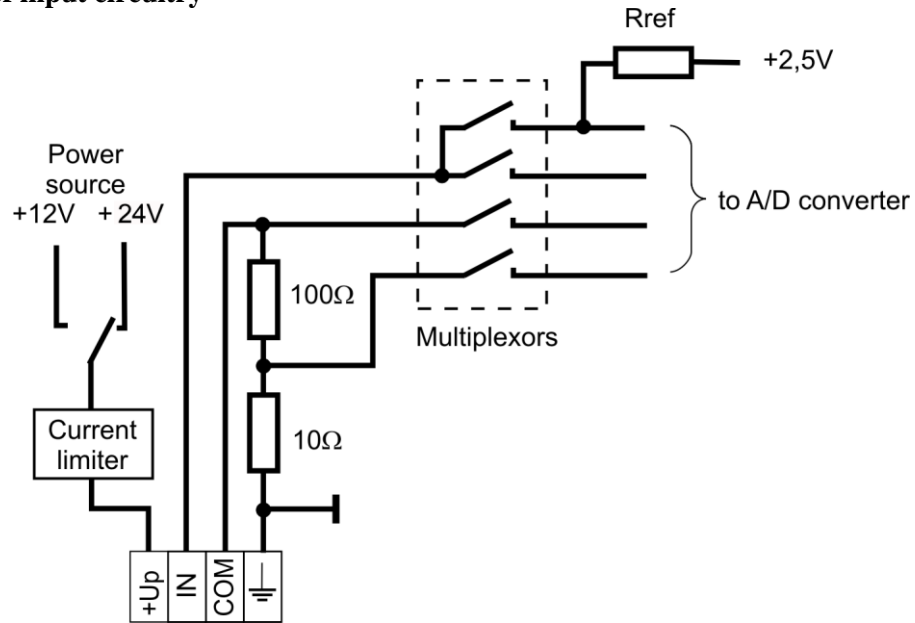

Read **Technical parameters of inputs** before connecting input signals

Terminal +Up can be used for powering of connected device (maximum current see **Technical parameters of inputs**). Default switch position is +24 V. If connected devices need lower voltage (13.8 V max), change switch to +12 V position.

**WARNING** – wrong manipulation with switch can damage connected devices!

## Connection of device with current output (4 to 20) mA to data logger input

- by means of current loops connection of device up to 1000m distance is enabled. Mind all rules of correct routing and connection, especially with longer distances and in environment with electromagnetic interference.
- active current source connect between terminals COM (positive pole) and GND (negative pole).

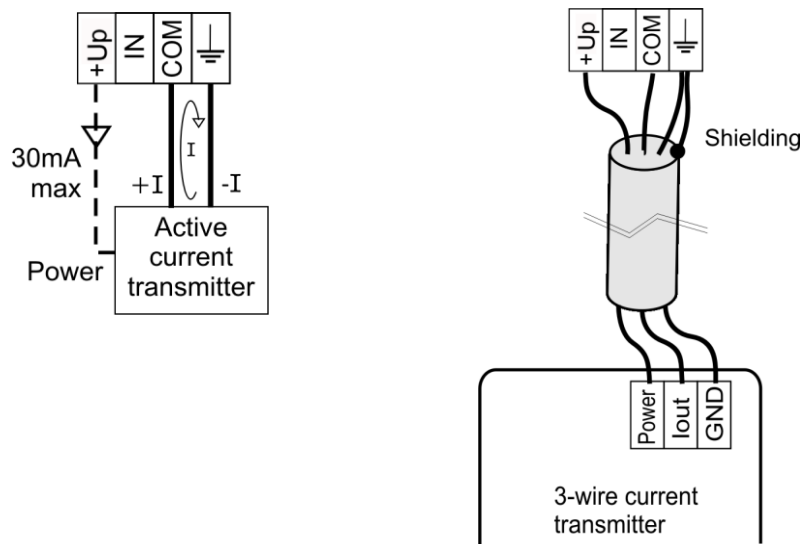

- connect passive two-wire current transmitter between terminals +Up and COM. Verify, if power voltage (see Technical parameters of inputs) matches connected transmitter.

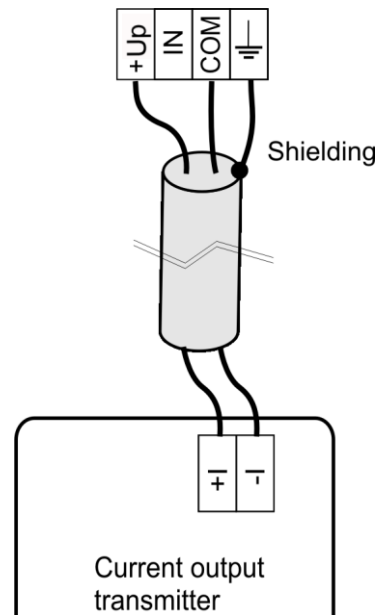
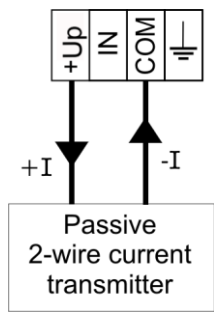

Insertion of other devices to current loops is possible (panel displays, computer measuring cards etc. But output circuitry of such devices must be galvanically isolated, otherwise undesired current coupling is created, causing error and unstable measurement.

### Connection of device with voltage output data logger input

- use shielded leads for voltage measurement - maximum distance about 15 m
- connect measured voltage between terminals IN and COM. Terminal +Up can be used for transmitter powering if needed (see Technical parameters of inputs) . In this case use terminal GND instead of terminal COM.

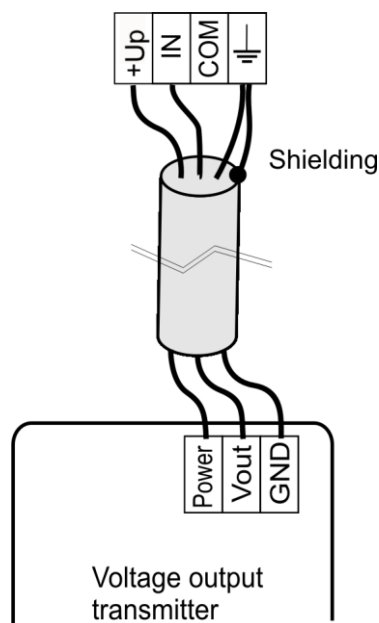
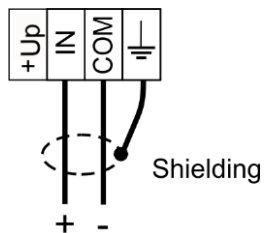

## Connection of thermocouple probes

- connect thermocouples in the same way as voltage signals. Use shielded thermocouple wires for longer distances.
- each wire between data logger and thermocouple must be from proper thermocouple material
- for extension use compensation cable designed for applied thermocouple - thermocouples cannot be extended by usual copper leads!

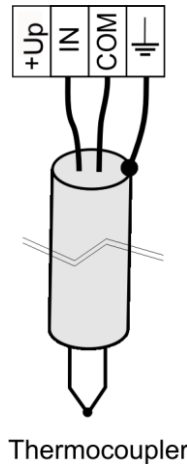

Marking of subminiature thermocouple connectors and wires manufactured by OMEGA (in accordance with US standard):

Type of thermocouple	Connector color	+ wire color	- wire color
K (NiCr-Ni)	Yellow	Yellow	Red
J (Fe-Co)	Black	White	Red
S (Pt10%Rh-Pt)	Green	Black	Red
B (Pt30%Rh-Pt)	White	Black	Red
T (Cu-CuNi)	Blue	Blue	Red
N (NiCrSi-NiSiMg)	Orange	Orange	Red



If there are more thermocouple inputs in data logger not galvanically isolated, avoid thermocouples to be mutually connected. If hazard of current leakage exists (mostly between thermocouple welded point and surrounding metal framework), thermocouple probes with galvanic isolated weld from outer probe shield or other measuring method should be used (e.g. external thermocouple/current loop transducers with galvanic isolation). In other case high measuring errors can appear.

**Warning** - cold junction temperature is sensed at area between channel 8 and channel 9, where the accuracy and the measuring stability is best. If using thermocouples, mind correct data logger working position (vertically, input terminals downward and sufficient ambient air flow). In no case install data logger with thermocouples horizontally, to the rack and to places with temperature fluctuations. Avoid higher input voltage than  $\pm 10V$ . Also avoid short circuits of terminals +Up with COM or GND. All such circumstances cause undesired temperature fluctuation and influence temperature measurement of thermocouple cold junction and this way also result temperature measurement!



### Connection of RTD transmitters and other resistance transmitters

- data logger enables two-wire connection
- use sufficient wire cross section and minimum cable lengths (errors caused by cable resistance are specified in *Appendix No. 6*)
- cable resistance measurement error can be compensated by suitable data logger setting

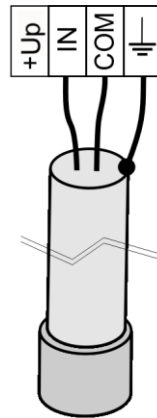

Pt100/Pt1000/Ni1000/NTC  
temperature sensor (2-wire)

### Connection of binary inputs

- If input is configured as binary, potential-less contact or open collector or voltage levels can be connected
- read parameters of the input in chapter Technical parameters of inputs

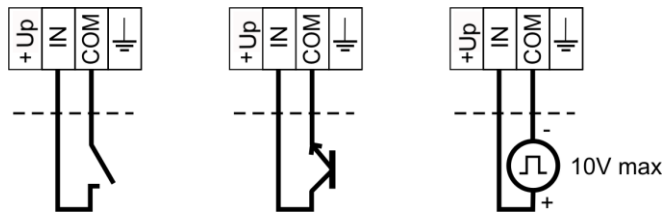

### Connection of transmitters with RS485 digital output to RS485 input

- Use suitable shielded twisted two-wire, e.g.  $2 \times 0.5 \text{ mm}^2$ , if using cable SYKFY  $2 \times 2 \times 0.5 \text{ mm}^2$ , spare pair can be used for transmitter powering.
- It is recommended to terminate the link with resistor  $120 \Omega$  at the beginning and the end of the link. For shorter distances termination resistor can be omitted.
- **NOTE - only devices communicating at the same communication speed and same protocol can be connected to the input!**
- input is galvanically isolated from data logger
- available source +24 V can be used for powering of transmitters (for its load rating see section Technical parameters of inputs)

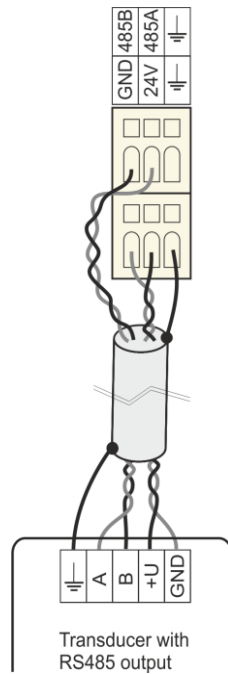

### Connection of output ALARM OUT

This output je accessible on terminals next to data logger power terminals. Output is dual:

- switching-over galvanically isolated relay contact
- voltage (galvanically connected to data logger)

The output is set from the manufacturer, that in case of selected alarm voltage appears at the output and simultaneously relay closes. It is enabled to set opposite behavior in data logger configuration (then data logger power dropout behaves as alarm state).

Activity of this output can be cancelled from data logger keyboard by the user or remotely from the PC. It is enabled to identify by proper data logger configuration, who cancelled the alarm.

It is possible to connect to this output:

- **External audio indication unit** - use shielded cable up to 100 m from data logger. Connect terminal ALARM OUT and GND on data logger with the audio unit in corresponding polarity. Connector CINCH of audio indication unit has positive pole on its central lead.
- **Telephone dialer** – in case of alarm telephone dialer dials specified telephone number and announces voice message. Depending on telephone dialer type use voltage output or relay contact.
- Simultaneously galvanically isolated contact relay can be used for **control of other devices**. If indication controls external circuitry, it is recommended to set delay after activation at least 10 seconds to prevent possible false alerts.
- Mind to adjust suitable delay for proper conditions of alarm creation to prevent possible false alarms.

### 3.3. Mounting and connection of output relays module MP018 and MP050

Module contains 16 output relays with switching-over contact, which can be used for control of external devices (see [parameters of relay](#)). It is possible to assign any number of relays to any alarm to be closed if alarm appears. Relays are identified by numbers 1 to 16. Each relay has three self-locking terminals (switching-over contact). Activity of relay can be checked visually on assigned LED diodes.

Relay module MP018 is designed for mounting to switchboard with corresponding protection. Fix module (140x211 mm) by means of DIN rail holder MP019 or screw by means of side wall holders MP013 with four suitable screws (mounting holes are identical as for data logger with wall holders MP013, see figure above). Connection of MP050 module with MS6-Rack is mentioned in Introduction part of this manual.



**For MS6:** use original included screws to mount side brackets or DIN rail holder. Using longer screws can cause reduction of insulation distance between screws and printed circuit board or short circuits. This can cause system functionality and safety of the users!

**For MS6-Rack:** Do not connect to MP050 terminals higher voltage than 50V AC/75V DC

Connect **MP018** module (for MS6, MS6D, MS6R) to data logger with special cable MP017 (see its wiring in *Appendix No. 4* including drawing of connection terminals to this module). Connect module when data logger is switched off! Plug one cable end to corresponding connector on relay module, second end to data logger, connector Ext. Terminal & Relays (upper or lower connector half can be used, both parts are connected identically). Connect slave device on output terminals of relay. Pay attention to necessary safety (depending on the character of connected device). Connect **MP050** module (for MS6-Rack only) with included cable to internal terminal of data logger behind Ext. terminal output. Relay module must be activated for proper function by means of SW – see *Appendix No. 5*. If data logger is delivered together with this module, function is activated from the manufacturer.

### 3.4. Mounting and connection of external terminal with display

External terminal with display is designed for visualization of measured values, alarms and for data logger controlling from point up to maximum 50 m from data logger. Its function is identical with internal built-in display of MS6 (keyboard and display work in parallel). The part of the display is also audio indication working analogically as *external audio indication unit* connected to output ALARM OUT.

External terminal is delivered in two versions. As a module prepared for installing to suitable case or in compact case. Module version can be mounted to the lid of light current switchboard or to stand alone case. Cut rectangle opening **156 x 96 mm to the lid**, install terminal module. Insert four screws from front side and screw them to metal holders from the inside. Tighten screws slightly from front side and cover with blinders.

Connect external terminal to data logger with special cable (wiring diagram is specified in *Appendix No. 4*). Connect when data logger is switched off! Follow identical rules for cable routing as for input signals. Plug one cable end to corresponding connector on display unit, second end to data logger, connector Ext. Terminal & Relays (upper or lower connector half can be used, both parts are connected identically). External terminal must be activated for proper function by means of SW – see *Appendix No. 5*. If data logger is delivered together with this module, function is activated from the manufacturer.

### 3.5. Connection of data logger to the computer

*Data logger contains for communication with computer one internal communication interface, which is separated to several external interfaces. Data logger communicates only via one selected interface:*

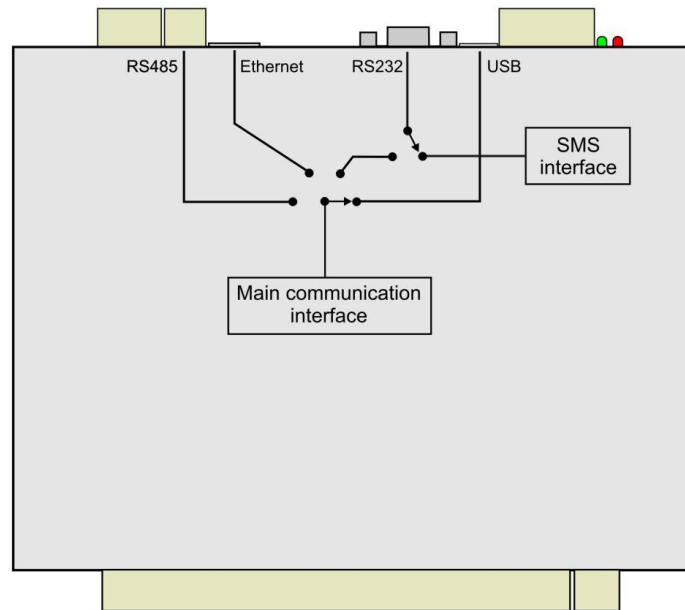

Communication interface can be selected from data logger keyboard or by means of PC program.

***In accordance with the way of work with data logger select most suitable way of its connection to the computer:***

- a) data logger will be used as a portable device and to computer (e.g. notebook) will be connected only time from time
  - use communication interface USB (up to 5m distance)
- b) data logger is installed close to the computer
  - use communication interface USB up to 5m distance) or
  - use communication interface RS232 (up to 15m distance), if computer is equipped with this interface
- c) data logger is far from the computer
  - use communication interface RS485 (up to 1200m)
  - use Ethernet network
  - use connection via GSM modems

See **Appendix No.3.** for detailed description of connections, cables, accessories, and settings.

**Character of communication interfaces:**

- a) **communication interface RS232** – connect data logger connector RS232C by cross-over RS232 cable of length up to 15 meters to computer communication port RS232C (COM port).
  - + historical, but practically trouble-free communication interface
  - + simple setting
  - some newer computers are not equipped with this interface
- b) **communication interface USB** - connect data logger communication interface USB by means of USB cable A-B of length up to 5 meters to the computer communication port USB
  - + practically all newer computers have this interface
  - + relatively easy setting (similarly as RS232)

- necessary to install suitable drivers, which interpret the device as virtual COM port
  - if data logger is disconnected from the computer often, it is suitable to use always the same USB socket (if using different USB socket operational system can consider as different port and user PC program does not recognize this change)
- c) **communication interface Ethernet** - connect data logger Ethernet interface by means of suitable UTP cable with RJ-45 connector to existing LAN network.
- + practically unlimited distance between data logger and computer
  - + communication and sending alarm messages by means of several network protocols is enabled
  - + mostly it not necessary to build other cabling
  - higher interface price
  - it is necessary to cooperate with network administrator (address allocation, ...)
  - more difficult trouble shooting
- d) **communication interface RS485** – connect data loggers and the computer to the RS485 bus (max. 1200 m).
- + network is autonomous, operation is not dependent on third parties
  - + up to 32 data loggers can be connected to one RS485 network
  - special independent cabling must be routed, higher labour consumption and price
  - external converter must be used at computer side to connect computer
- e) **RS232 communication interface with GSM modem for work with data logger and for SMS messages** – connect data logger communication interface RS232C to preconfigured GSM modem, second modem will be at computer side
- + practically unlimited distance between computer and data logger (depend on coverage of operator signal)
  - + SMS messages can be used
  - communication and SMS messages are charged by the GSM operator
  - operation reliability depends on third party

There must be GSM modem also at the computer side and data logger must be configured to communication interface RS232. Then all usual communications can be performed by means of user program via GSM network. Also SMS messaging can be used. Testing of incoming SMS messages and sending of alarm SMS messages is performed with the 2 minutes interval, if data connection is not active. If there is an active connection, SMS messages are not received and sent until connection is deactivated.

### 3.6. Connection of data logger with support of SMS messaging

Connect data logger communication interface RS232C to preconfigured GSM modem. Case when GSM modem is used not only for SMS messages, but also for communication with data logger is described above. If data logger is connected to the computer by means of different interface than RS232, GSM modem can be connected to RS232 connector and used for SMS messaging. For detailed description see *Appendix No. 3*

### 3.7. Connection of data logger to power

Data logger is powered from suitable power source (can be ordered). When powered from a different source it is necessary to use dc voltage at range specified in technical parameters of data logger. Data logger consumption in different variations is specified in *Appendix No. 1*. Appendix No. 1 describes also several possibilities of data logger power back-up.

## 4. CONTROL and INDICATION COMPONENTS of DATA LOGGER

### 4.1. Indication of power and state of output ALARM OUT

Indication is performed visually by LED diodes located at case side next to power terminals (*see Drawing*). Green LED indicates the presence of power voltage, red LED activity of output ALARM OUT.

### 4.2. Display and keyboard

Left from display are three indication LED diodes:

- Power - indication of presence of power voltage
- Memory (orange) - indication of exceeding of adjusted memory occupation limit
- Error – lights if configuration violence of data logger appears or error in self test appears

Display is dual line, display can be controlled by means of four button keyboard located next below it (buttons MENU,▲,▼,ENTER). After connection of data logger to power self test of several internal voltages is performed first. If everything correct, data logger starts to display values. Figures below are valid for MS6D. For data logger MS6R only location of the keyboard differs.

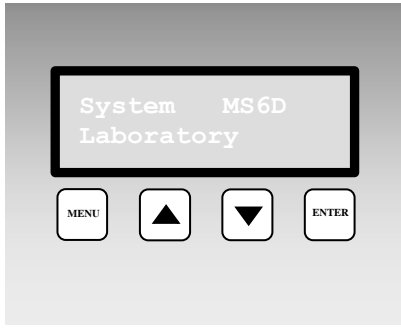
	<p><b>Display after connection power to data logger.</b> Datalogger model and name is displayed for several seconds. Then data logger evaluates self test of internal voltages. If everything correct, data logger starts to display values. If self test is not correct, data logger reports Self Test Error with specified voltage, which is not correct (power voltage, internal battery and source of negative voltage). The failure is necessary to fix. If specified error message is confirmed by pressing ENTER key, data logger goes on to basic display.</p>
--	--

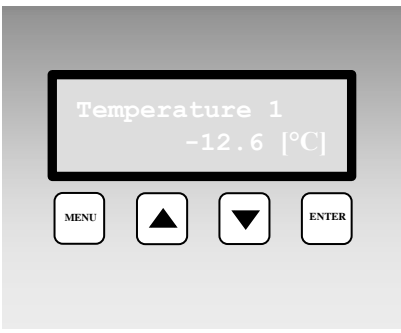
	<p><b>Basic display on the LCD</b> In basic display upper line displays user specified name of measuring point, adjusted from user program. Lower line displays measured value with physical unit respective state of input channel. All active channels can be checked by keys ▲,▼. Error message can occur instead of measured value. Binary inputs display at the whole LCD bottom line user defined description of state closed/open. In case value is not available or is not correct error message is displayed – see <i>Appendix No. 7</i>.</p>
---	--

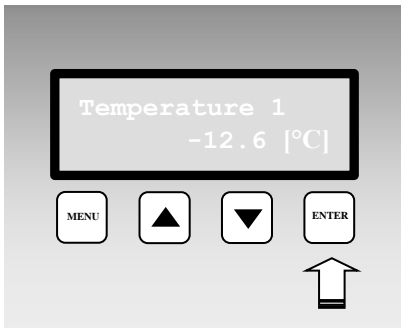
	<p><b>Deactivation of audible alarm signalization and output ALARM OUT by pressing ENTER key</b></p> <p>If is this function is enabled, then in basic display of measured values short pressing of this key deactivates audible indication and ALARM OUT output optionally. In case another alarm appears with requirement for audible indication, alarm will be activated. Similarly, if data logger deactivates alarm, which activated audible indication and consequently this alarm appears again, it is activated.</p> <p><i>Other options for deactivation of alarm signalization are specified in <u>Application notes</u>.</i></p>
---	--

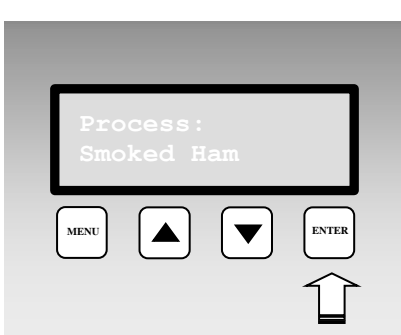
	<p><b>Display of adjusted process</b></p> <p>If using <i>Processes</i>, shortly press ENTER key in basic display mode on required channel to display actual process in progress.</p>
---	--

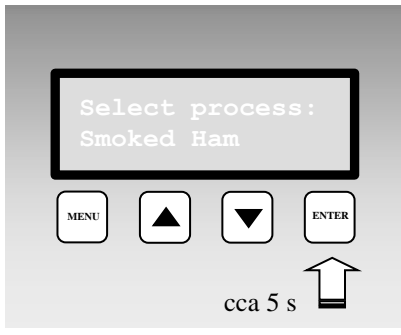
	<p><b>Selection of new process</b></p> <p>If using <i>Processes</i>, press and hold for about 5s ENTER key in basic display to enter selection of preset processes. Use ▲, ▼ keys to go through process names enabled for input channel. If no process is needed use selection No process. Press ENTER key to activate selected process.</p> <p>Press MENU key to leave the display without storing new process.</p>
---	--

**Items and function available in Menu data logger**

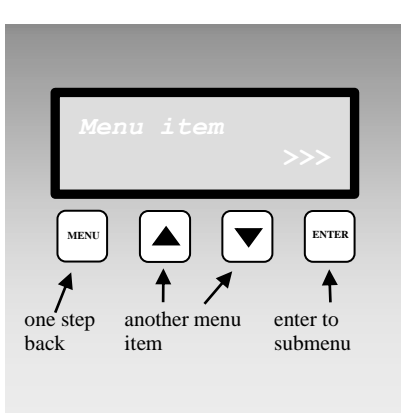
	<p>Press MENU key in basic display to enter the data logger Menu. Use ▲, ▼ keys to go through all menu items. Press MENU key to leave menu to the basic display.</p>
---	--

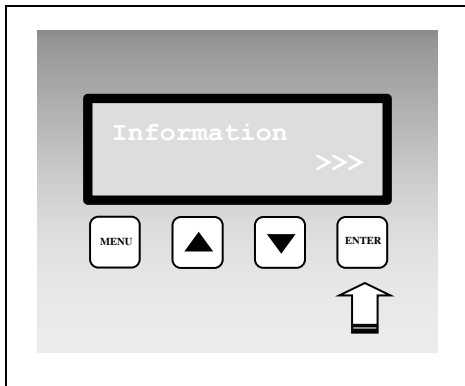

**Menu item Information**

Item Information contains another Sub-Menu. Press ENTER key to enter sub-menu and use ▲, ▼ keys to move between items. Leave Sub-Menu by pressing MENU key. In submenu **Information** it is possible to display one fixed message after another Data Logger Model, Data Logger Name, Serial number, Record mode (cyclic/non-cyclic), Memory occupation, Date and time in data logger, Language .

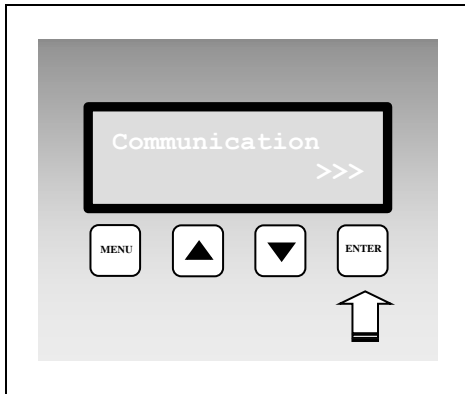

**Menu item Communication**

Submenu Communication – enables to display and change Setting of communication interface, Communication speed, Data logger address in the RS485 network, data logger IP address, Gate IP address and Net Mask. Displayed items in menu depends on actually adjusted communication interface and optionally on implemented HW. *Change of configuration can be selectable protected by PIN code, entered by the user. Way of entering PIN code is specified in Application notes.*

**Change of data logger communication interface**

Press ENTER key to enter selection of communication interface. Use ▲, ▼ keys to select required communication interface and press ENTER key to confirm the selection. Adjusted communication interface must correspond with physical connection and with SW configuration. If you choose selection Ethernet-DHCP, IP address is set and gate address to 0.0.0.0, network mask is set to Default (0).

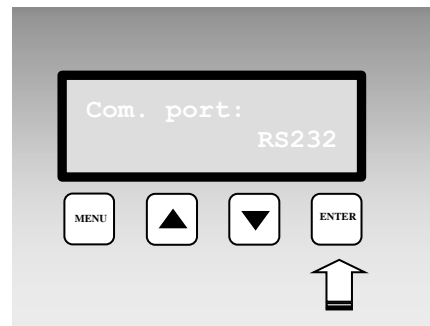

**Change of data logger communication speed**

Press ENTER key to enter selection of communication speed. Use ▲, ▼ keys to select required communication speed and press ENTER key to confirm the selection. This selection is not available for Ethernet. **ATTENTION** – standard computer COM port does not support communication speed 230 400 Bd. If data logger supports such speed, then it can be used in USB connection.

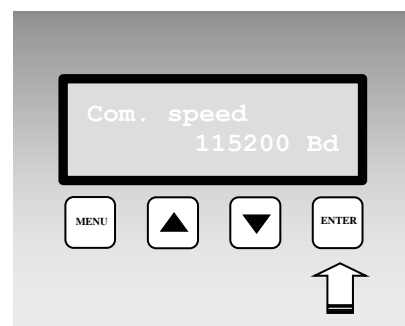



### Change of data logger RS485 address

Press ENTER key to enter address selection. By means of ▲, ▼ keys select new address and press ENTER key to confirm selection. This selection is available only for active RS485 interface.

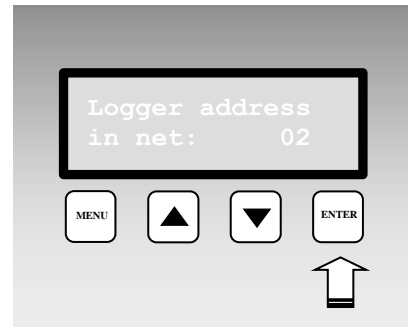

### Change of data logger IP address

Press ENTER key to enter selection of data logger IP address. First position blinks. Select desired digit by means of arrow keys ▲, ▼. Press ENTER to go to next position. After editing the last position new data logger address is stored. This selection is available only for active Ethernet interface. Be careful in IP address setting. Incorrectly set address can cause network conflict or other complications. Always consult IP address setting with network administrator.

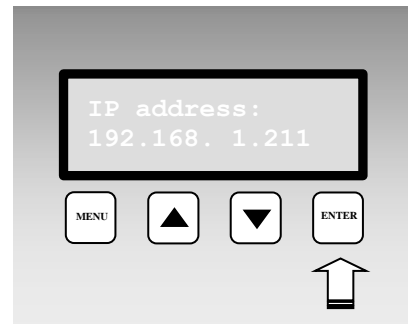

### Change of gate IP address

Setting is analogical as for IP address. This selection is available only for active Ethernet interface. Be careful in gate IP address setting. Incorrectly set gate address can cause network conflict or other complications. Always consult IP address setting with network administrator.

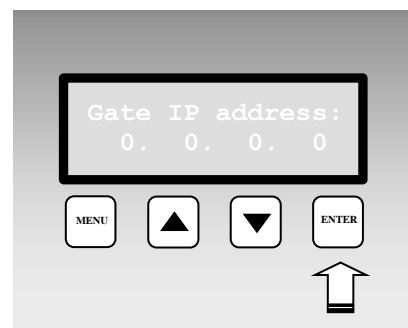

### Change of network mask

Press ENTER key to enter selection of network mask. Select desired network mask by means of arrow keys ▲, ▼. Press ENTER to store mask to data logger. Network mask 255.255.255.255 is displayed as Default. This selection is available only for active Ethernet interface. Be careful in network mask setting. If not necessary, do not change Default value. Incorrectly set network mask can cause data logger inaccessibility. Always consult network mask setting with network administrator.



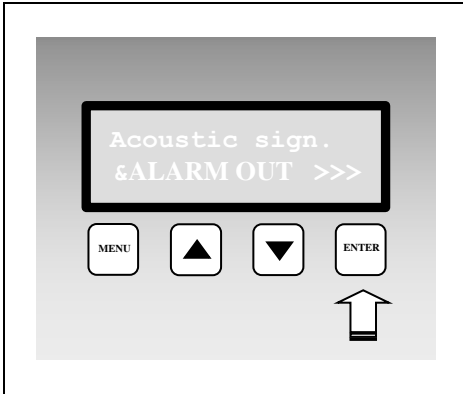

**Menu item Acoustic signalization & ALARM OUT**  
 Submenu for switch OFF the audio indication. This item appears **only if user allowed in Common parameters Alarm Confirmation via menu**. After entering actual states of audio indication and ALARM OUT output are displayed. If in active state, it is possible to deactivate by pressing ENTER key. New activation can be caused by creation of new alarm or by ending of alarm and new alarm creation, which caused this action. In case password requirement function is activated in SW, it is necessary to enter password first. *Way of entering PIN code and other options are specified in [Application notes](#).*

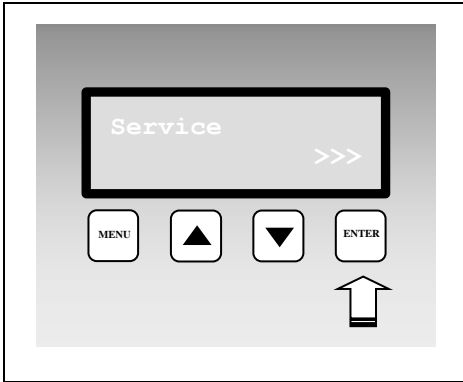

**Menu item Service**  
 Submenu enabling to display value of some Service parameters of data logger.

**Service – display of self test of internal voltages**  
 Self test of data logger internal voltage. First value indicates approximate power voltage (9 to 30 V, see technical parameters). Second value is voltage of negative source (-14V to -16V) and third value is voltage of internal back-up battery (2,6V to 3,3 V).

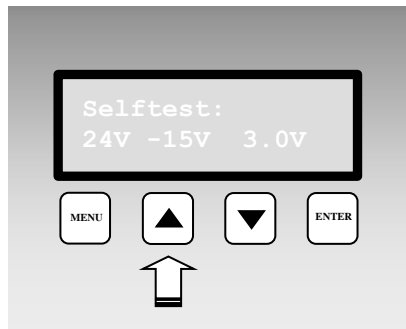

**Service – display of firmware version and uP speed**

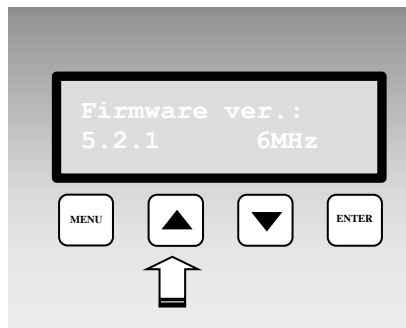

**Service – display of cold junction temperature of thermocouple**

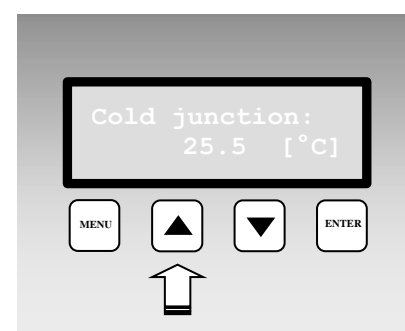

**Service – display of state of processing SMS**

Actual state of communication with GSM modem is displayed on the LCD. Press ENTER key to enter directly the display of receiving and sending SMS buffer.

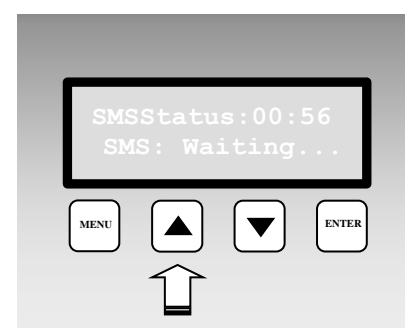

**Service – display of A/D converter values for measured channels**

Value read from A/D converter of analog inputs at range 0 to 65535. Limit value 0 indicates converter lower limitation (corresponds to Error1) and value 65535 (corresponds to Error 2) indicates converter upper limitation. With counter inputs binary state of counter is displayed. With binary inputs state of input (ON/OFF) is displayed and with RS485 input symbols „---“ are displayed.

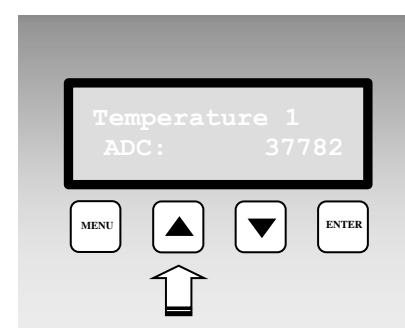

## **5. USER PROGRAM FOR DATA LOGGER**

*The following text describes especially possibilities of data logger setting and some procedures of work with data. More detailed information on program is in Program Help.*

### **5.1. Program features**

Software for data logger enables to configure data logger and process measured data. It can be downloaded freely from [www.cometsystem.com](http://www.cometsystem.com). After installation program can run in two modes as:

- **basic (unregistered) version** – enables configuration of data loggers and table processing of data. It does not enable graphic processing of data, automatic data download, storing of data outside of local computer, www display etc.
- **optional (registered) version** – after entering of purchased registration key optional functions of the SW are enabled. Entering of key is enabled in installation of the SW or anytime later.

#### **Hardware and software requirements:**

- the Windows 7 and later or the Windows Server 2008 R2 and later operating system
- 1.4 GHz processor
- RAM 1 GB

### **5.2. Installation of program**

Run downloaded installation utility for MS data loggers. Installation wizard appears to perform all installation. Run installed program from menu Start-Program files-CometLoggers-MSPlus (if you did not change its location during installation).

*For other USB devices, e.g. ELO214, installation of proper drivers to these devices is necessary.*

### **5.3. Setting of communication with data logger**

User SW enables to work simultaneously with several data loggers connected in different ways to the computer. Settings is performed in two steps:

- Selection of communication interface of the computer
- Data logger assigning to selected communication interface

You can find description of individual settings in the Appendix no. 3.

*If SW installation was just completed and the window Setting of communication is empty, then with data logger connected via RS232 and USB steps described below must not be performed. Connect data logger to the computer (wait with USB for awhile to let the system detect connected device and activate virtual COM port driver). **Then** run user SW and try to read data logger configuration (icon **i**). Computer searches all available COM ports and speeds and tries to find data logger. If this procedure fails or different interface is required or there are more than one data logger, follow below instructions. Optionally see detailed description in **Appendix No. 3**.*



*Configuration in data logger must correspond with setting in computer. E.g. If data logger is set to RS232 interface and in SW Ethernet is used, data logger is not able to communicate.*

*If SW services several data loggers at the same time, you will be asked to choose data logger from the list before each communication with data logger. In the mode Display all data loggers are displayed in parallel (with the exception of those connected via modem).*

## 5.4. Basic items in menu program

### Item menu **File**:

- reading stored file from disk to the program and display data into the table.  
*Data in files are stored on disk in a special binary format, which is not compatible with standard formats. In case, value in table is not available or is not correct, error message is displayed – more information see in **Appendix No. 7***
- reading data from data logger  
*After this selection window for selection of data logger is displayed (if there are more than one) , user can select name of file, where data will be stored and after if data logger will be erased after data transfer*
- configuration of the printer
- configuration of program Options – *only in optional version of program*
- configuration of language localization
- logout of user – *only in optional version of program*

### Item menu **Show**:

- table – *displays measured values, can be set different numbers of channels. Exports to dbf and xls format are available*
- graph – *only in optional version of program*
- Event viewer – *here actions are stored run by the SW with data logger and theirs result*

### Item menu **Configuration**:

- Data logger settings – *detailed description will follow*
- Erase data logger memory – *after confirmation erasing is performed*
- Reset counter inputs and erase memory - *this selection is not valid for data logger MS6D, MS6R.*
- Reading configuration from file – *reads configuration from already downloaded file with data record. Configuration can be stored back to data logger or to the file.*
- Deactivate alarm signalisation – *if it's enabled, it is possible to cancel activity of ALARM OUT output remotely from the PC.*
- Communication settings – *you can find configuration description in the Appendix no. 3.*

Item of menu **Display** - *online visualization of measured values on the computer, reading interval can be set in section File-Options, bookmark Display (in basic version it is fixed to 10 s, in optional version can be set from 10 s). In suitable configuration the mode can be shared on several computers. See Application notes.*

## 6. DESCRIPTION of CONFIGURATION and DATA LOGGER MODES

Use menu item *Configuration – Datalogger configuration* to configure data logger parameters. After reading of configuration window is displayed with several bookmarks.



*When changing configuration of data logger, all recorded data erasing can be required by the SW.*

### 6.1. Bookmark *Common*

- enter data logger **name** – maximum length is 16 characters, use letters (no diacritic marks), digits, underline.  
*A folder under this name is created in computer, to store downloaded files with recorded data in. Data logger name is displayed on the display after switching on and is available in data logger Menu. The name is used for identification in user SW.*
- check if **Date and time** in data logger is set correctly
- **Security**
  - if you need to define names and rights users of the system including protection of communication, then switch on *Datalogger security On/Off* and define each system user.
  - if you need to assign PIN codes to users for their identification in canceling of alarm signalization or optionally other rights, do it in window *User account – Details* (available due to *Users and password* button and option *Properties*) and switch on *Alarm confirmation by PIN1* and create new PIN code. If using system of security with PIN, always will be required PIN code after *Confirmation of alarm signalization* and *Condition setting from PC*.
  - if you need to secure some menu items of data logger against arbitrary overwriting, tick proper selection and enter PIN2. *This PIN2 is different from users' PIN.*



*If you use Users and password and forget the Username or password, then it is not possible to recover the communication in simple way!*

- if you will need to mark parts of record with your notes during operation from data logger keyboard, use **Processes**. More detailed description is specified in chapter *Application notes*.
- if you will use alarm output **ALARM OUT**, define, if and how data logger user can cancel its activity. *If you need to identify person, alarm was cancelled by, proceed in accordance with chapter Application notes.*

### 6.2. Bookmark *Communication*

Here you can set:

- **Data logger communication interface** - you can change the type of used data logger communication interface



*Change of communication interface can cause after storing data logger configuration you would have to physically connect via this interface and change data in Communication setting. The change of communication interface and communication parameters setting can be performed directly from data logger keyboard.*

- **Baud-rate** – preset value is 115 200 Bd. If you use classic connection via RS232 (COM port), then this is the highest available speed. For USB connection you can use higher speed (in case it is supported by data logger). For Ethernet interface cannot be changes. For RS485 with larger networks a need to decrease the speed can appear.

- **RS485 network address** – relevant in communication via RS485, each data logger in the network must have different address!
- **Data logger responds to incoming SMS messages** – if data logger is connected to GSM modem, you can get actual measured values and alarm states by sending SMS from mobile telephone to number of modem. Data logger reacts on this text of received SMS messages: **Info, Alarm, Ch1 to Ch16, Set1 to Set16, Clr1 to Clr16**. For more details see chapter *Application notes*.
- **Data logger sends SMS message when selected alarms are activated** – if data logger is connected to GSM modem, you can assign one to four phone numbers to each alarm states warning SMS message containing description of created alarm is sent to.
- **Datalogger sends scheduled SMS** - if data logger is connected to GSM modem, then it can send scheduled SMS messages (information that system works correctly) to the selected phone numbers at specified hour and days per week. This feature is available for FW version 6.3.0 and later.

*Quick and reliable SMS message delivery depends on quality of GSM network. Data logger has no information on credit on the SIM card. Use suitable tariff.*

**Features and settings of data logger Ethernet interface:**

*If data logger has installed and enabled Ethernet interface, then functions of this interface can be set at the right part of the window. Always contact your network administrator with setting of IP address, gate address and subnet mask to get correct values. Be very careful in network settings. Incorrect adjustment can cause data logger inaccessibility, conflict in network or other complications.*

It is possible to set:

IP address of data logger – it must be unique address in your network, assigned by your network administrator (if you use DHCP, tick this selection, address then will be presented as 0.0.0.0.)

IP address of gateway – address of gateway or router, providing communication with other LAN segments. Address of gateway must be at the same network segment as data logger.

Mask of subnetwork – defines range of possible IP addresses in local network, e.g. 255.255.255.0

Size of MTU – size of packets, default is 1400 bytes. It is possible to lower it with some networks.

Sending of warning e-mails - if ticked, warning e-mails will be sent to below specified addresses

Sending of traps - if ticked, warning SNMP traps will be sent to below specified addresses

SysLog - if ticked, warning messages will be sent to below address of SysLog server

Web enabled – if ticked, www pages of data logger will be created

SOAP – if ticked, actual measured values will be sent to below address of SOAP server (in mode „Display“)

*Bookmark Email (1):*

IP address of SMTP server - If needed to send e-mails by the data logger, it is necessary to set the address correctly. Administrator of your network or your internet provider gives you the value of the address.

SMTP authentication - Setting of username and password for login to server sending e-mails.

*Bookmark Email (2):*

Recipient of e-mails 1-3 - e-mail addresses of recipients. E-mails will be sent to those addresses in case of selected alarms

Sender - enables to set addresses of the e-mail sender. Selection Original sender sets sender name to <data logger name>@IP address

Send testing e-mail - sends testing e-mails to selected addresses

*Bookmark SNMP:*

Recipient of trap 1 – 3: IP addresses of recipients of SNMP traps.

Password for reading - setting of password for access to SNMP MIB tables.

Send testing trap - sends testing trap of 6/0 type to specified IP addresses.

#### *Bookmark Web*

Refresh - refresh time of automatic pages reading (update of displayed measured values). Range 10-65535 s.

Port – TCP port, built-in WEB server will be receiving queries. Default value is 80.

#### *Bookmark Syslog*

IP address of SysLog server 1-3 – IP address of servers, messages are sent to.

Send test message – sends test Syslog message to specified servers

#### *Bookmark SOAP*

IP address of SOAP server – IP address of server, on-line measured values, messages with data logger and alarms state are sent to (similar to the „Display“mode)

Target web page – name of pages, where server has running script for incoming message processing

Source port – port number, data logger sends SOAP message from. Default set to 8080

Target port – port of server, where SOAP message is expected

Sending interval – how often data logger sends data to server

### 6.3. Bookmark *Profile*

- ***Cyclic record*** – if it is not ticked, then after fulfilling of memory data record ends. Measurement and evaluation of alarms continues. If it is ticked, then after fulfilling of memory oldest data are overwriting with newest.
- ***Alternative record times*** – record must not run in fixed time intervals, but it is enabled also to define up to four times in day, when measured values will be stored.
- ***Language*** – language localization of fixed messages on data logger LCD. It does not apply to language localization of program
- ***Alarm signalization*** – alarms can also be signalized acoustically or by ALARM OUT output. Signalization of alarm can be deactivated (cancelled) by the user if it is enabled. It can be done in several ways:
  - by pressing of the ENTER key on data logger
  - by means of data logger menu with possibility to require PIN of user
  - remotely from the computer

In case alarm which activated the signalization is cancelled and appears again, signalization is activated again. Confirmation (deactivation) of signalization simultaneously refers to internal audible indication and to ALARM OUT output. For newer FW versions other options are available – see *Application notes*.

- if there is a need to indicate acoustically some alarms directly in data logger, tick *Internal acoustic alarm signalization* and specify for each alarm, if alarm is indicated this way.
  - If there is a need to activate ALARM OUT output, tick ALARM OUT and specify for each alarm, if alarm is indicated this way.
  - changes of ALARM OUT output state can be recorded, and it is enabled consequently to identify the user canceling the alarm by means of *Administration of users and passwords*.
  - if there is a need to record changes of all alarm states, tick selection ***Recording of ALARM OUT state changes*** and ***Recording of all alarms changes***
  - if there is a need to indicate acoustically the state of memory occupation, tick this selection
- ***SMS phone number list*** – if you use sending of SMS messages after alarm creation, then enter here telephone numbers for sending messages. *Enter numbers in international format with country code, e.g. 0049... or +49....*



- **Critical states actions** – it is enabled to assign actions similar to alarms to some error states, evaluated by data logger (error of measurement on some of input channels, error in configuration of data logger, reaching of specified occupation of data memory and self test error). Do not use zero duration time of critical state for evaluation of the action. Use at least 10s delay. If this state lasts this time without interruption, selected actions will be performed.

#### 6.4. Bookmark *Ch.. Identity & Calculations*

This and the following bookmark refer to data logger input channels to be switched over in left lower window corner.

Set your own identification of measured points and optional conversion of measured values at this bookmark:

- **Type of input channel** – here select type and range of input channel. Setting must correspond with the way of its connection to input terminals. It is possible to change if needed. If *binary input* or *input RS485* (if installed) is selected, several following selections can differ. *Interchannel recalculation* is specific type of input channel. By means of it is possible to acquire values as sum, difference or other combination of measured values from two another input channels:

$$MV = A * MV_j + B * MV_k + C$$

$$MV = A * MV_j * MV_k + C$$

$$MV = A * MV_j / MV_k + C$$

where MV are measured values, j,k are source channels

- in upper part of bookmark name and range of installed input module is specified for information.
- **Channel name:** - enter name of measured points in length of maximum 16 characters.
- **Physical unit** (except binary inputs) – you can select from the list or write your own in length of maximum 6 characters
- **Description of state open/closed** (in binary inputs) – user selectable strings in length 16 of characters to describe state „closed“/ „open“ resp. „without voltage“/ „with voltage“
- **Number of decimal places** (except binary inputs) – you can set maximum 5 digits behind decimal point.
- **Recalculation** (except binary inputs)- measured value from input can be recomputed by means of two-point linear transformation to other value. Default state is set to conversion 1:1 and full scale points of module input range module or value 0-0, 1-1 are used. Value can be arbitrary except for state when both input values are the same.

*Example: data logger with current input 4 - 20 mA is connected to temperature transducer with current output, which generates at temperature -30 °C output current 4 mA and at temperature 80 °C current 20 mA. Enter following values to the table:*

*Measured value 4.000 [ mA] will be shown as -30.0 [°C].*

*Measured value 20.000 [ mA] will be shown as 80.0 [°C].*

- **Processes** (except binary inputs) – allow which processes are enabled to use. See [Application notes](#).
- **Address of connected device, Maximum waiting** etc. – setting of RS485 input, for more information see [Appendix No.2](#).

#### 6.5. Bookmark *Ch.. Measuring & recording*

- tick **Input channel is measuring and fires alarms** to enable this channel for measuring,

- if there is a need record measured value, select one from three available record mode. These modes can be combined. *Binary inputs enable only the third mode – record of state changes on input.*

A) **Continuous record** - if there is a need to record measured value to the instrument memory without respecting any other conditions, use this selection and select suitable logging interval. Logging function can be limited in time both globally (i.e. Date and time from ...to) and daily (daily from...to).

*If no from offered logging intervals suit you, use record in alternative daily times, defined before on bookmark Profile.*

*Example of table with continuous record:*

Date and time	Channel 1: T[°C]
1.1.2009 08:00:00	23,8
1.1.2009 08:30:00	24,5
1.1.2009 09:00:00	26,8
1.1.2009 09:30:00	33,2
1.1.2009 10:00:00	37,5
1.1.2009 10:30:00	42,3
1.1.2009 11:00:00	45,1
1.1.2009 11:30:00	45,2
1.1.2009 12:00:00	44,1
1.1.2009 12:30:00	40,1
1.1.2009 13:00:00	35,2
1.1.2009 13:30:00	30,1

B) **Conditional record**– if there is need to record measured value to the instrument memory only in case, if defined conditions are valid, then use this selection. Select suitable logging interval and assign conditions for the record. Logging function can be limited in time both globally (i.e. Date and time from ...to) and daily (daily from...to).

*If no from offered logging intervals suit you, use record in alternative daily times, defined before on bookmark Profile.*

*Example of measured values list (condition for record – temperature is higher than 40°C):*

Date and time	Channel 10: T[°C]
1.1.2009 10:55:00	40,1
1.1.2009 11:00:00	41,3
1.1.2009 11:05:00	40,2
1.1.2009 11:30:00	40,3
1.1.2009 11:35:00	42,5
1.1.2009 11:40:00	40,1

By means of continuous and conditional record situation can be solved when device operation is monitored. In case of its trouble-free operation record with long logging interval is sufficient, but in case of failure there is a need to have detailed record with failure.

Example of list of measured values (continuous record with interval 30 minutes and conditional record with interval 5 minutes at temperature higher than 40°C):

Date and time	Channel 1: T[°C]	
1.1.2009 08:00:00	23,8	continuous
1.1.2009 08:30:00	24,5	continuous
1.1.2009 09:00:00	26,8	continuous
1.1.2009 09:30:00	33,2	continuous
1.1.2009 10:00:00	37,5	continuous
1.1.2009 10:30:00	39,3	continuous
1.1.2009 10:55:00	40,1	conditional
1.1.2009 11:00:00	41,3	continuous +conditional
1.1.2009 11:05:00	40,2	conditional
1.1.2009 11:30:00	40,3	continuous +conditional
1.1.2009 11:35:00	42,5	conditional
1.1.2009 11:40:00	40,1	conditional
1.1.2009 12:00:00	34,1	continuous
1.1.2009 12:30:00	30,1	continuous
1.1.2009 13:00:00	25,2	continuous
1.1.2009 13:30:00	20,1	continuous

Conditional record can be linked to a simple *Condition* or on logical *Combination of conditions* (maximum four conditions from different channels linked by operators AND and OR).

Example of conditional record in case of logical combination of conditions:

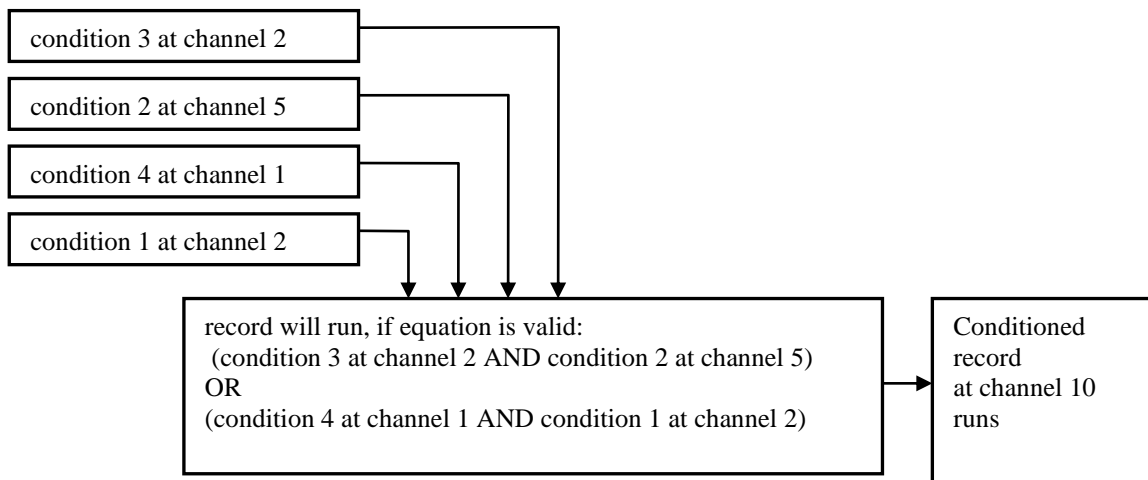

- C) **Sampled record** - if there is a need to know time and measured value when certain event appeared defined by *Condition* or *Combination of conditions*, use this selection. Work with conditions is similar as in previous case. Always time and value are stored when defined state of conditions started or was terminated.

Example table with sampled record:

Date and time	Channel 1: T[°C]
1.1.2009 08:01:11	23,8
1.1.2009 08:40:23	24,5
1.1.2009 09:05:07	26,8
1.1.2009 09:12:44	33,2
1.1.2009 10:08:09	37,5
1.1.2009 10:32:48	42,3

Record of binary channels behaves analogically as sampled record when each change on binary inputs is stored. Value is replaced by text description, which corresponds with user configuration.

### 6.6. Bookmark *Ch..Conditions*

*Condition* defines certain state of measured value (exceeding of adjusted limit upwards/downwards, defined state of binary input) on specified input channel. It can have two states: valid-invalid. Up to four independent conditions at one channel can be defined. Creation of alarm states depends on state of conditions and sampled, and conditional record can be controlled by them:

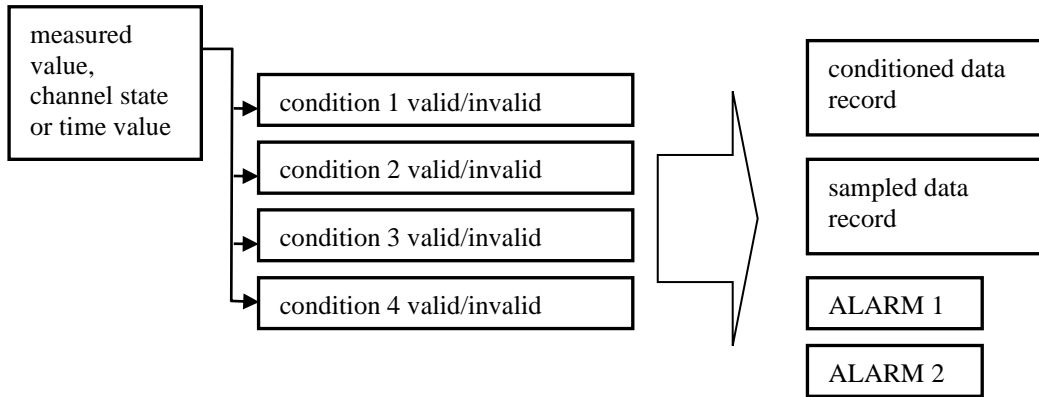

Data logger enables to set condition depending on measured value, on time and condition, which validity is remotely controlled. Each from four conditions it is possible to switch on for evaluation. Binary inputs have lower number of possibilities to set conditions, setting is analogical.

- A) If there is a need to activate some actions dependent on **Measured value**, select *Start of validity: Input value*  
*Example:*

Select, if condition will be valid, if measured (*Input*) value is higher or lower than adjusted limit (170) and how long must this state last without interruption (30 s, maximum 65535 s), than the condition becomes valid. Define further circumstances for termination of condition validity. If no validity termination is defined, condition remains permanently valid (till change of data logger configuration). You can select validity termination after value return with hysteresis (2) OR (optionally AND) if defined time expired (maximum 65535 s).

You can also define, how the state of the condition works if measurement error appears:

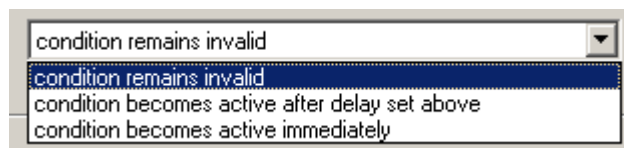

If other devices are controlled based on validity of the condition (relay outputs, sending of SMS message, audible indication etc.), always use nonzero hysteresis and nonzero time delay for creation of condition validity to avoid false alarms at transient effects of input value.

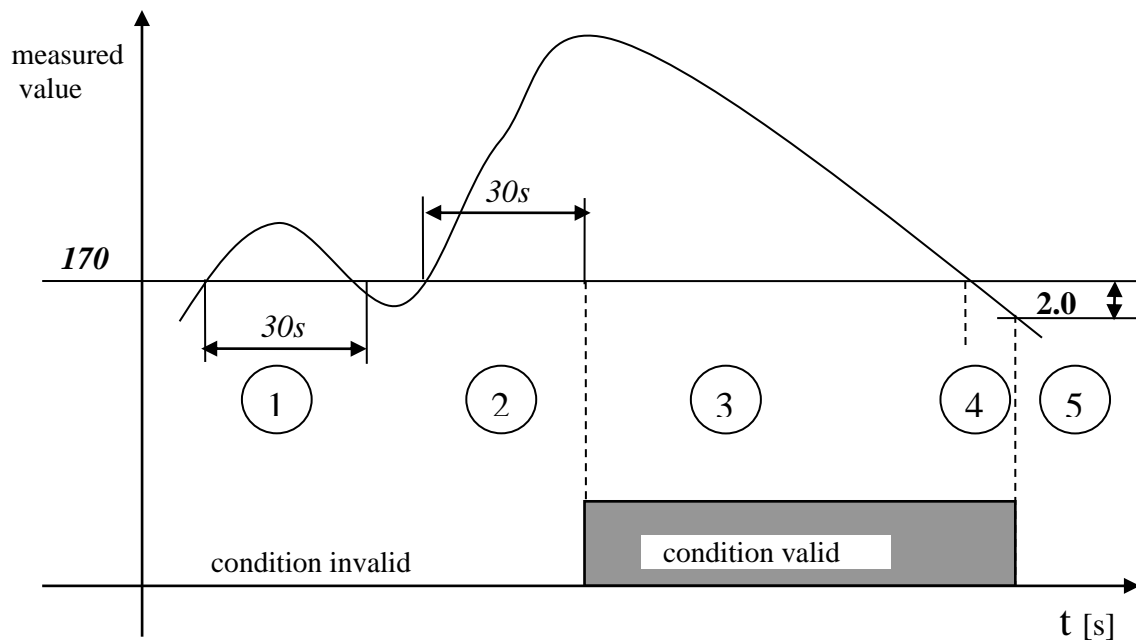

*Description of function:*

- Area 1... measured value exceeded limit, but was not over this limit for required duration, condition invalid.
- Area 2... measured value exceeded limit and was over this limit for required duration. After finishing adjusted condition became valid.
- Area 3... measured value is still over limit, condition is valid
- Area 4... measured value already dropped below limit, but nonzero hysteresis is adjusted, for finishing of condition validity measured value must drop of adjusted hysteresis value
- Area 5... measured value dropped below limit decreased of hysteresis, condition is invalid

*Switching of data logger power in different condition states:*

1. if power of data logger is switched OFF in area 2, after switching ON measured value is still over limit and required delay is not over, data logger continues in testing on, as no power failure would appear.
2. if power of data logger is switched OFF in area 2, after switching ON measured value is still over limit and required delay is over already, condition becomes valid immediately
3. if power of data logger is switched OFF in area 2 and after switching ON measured value is not over limit, cycle of time testing is interrupted (similarly as in area 1).
4. if power of data logger is switched OFF in area 3 or 4, after switching ON measured value is over limit decreased of hysteresis, condition stays valid. But if measured value does not match this, condition is invalid immediately.

*Other examples of configuration of conditions depended on measured value:*

- *Setting of condition validity at measured value drop:*

Condition 1

Start of validity:  <  °C for the duration of  s

End of validity:  value returns back with hysteresis  °C   expires  s

In the case of input error (measured value is not available):

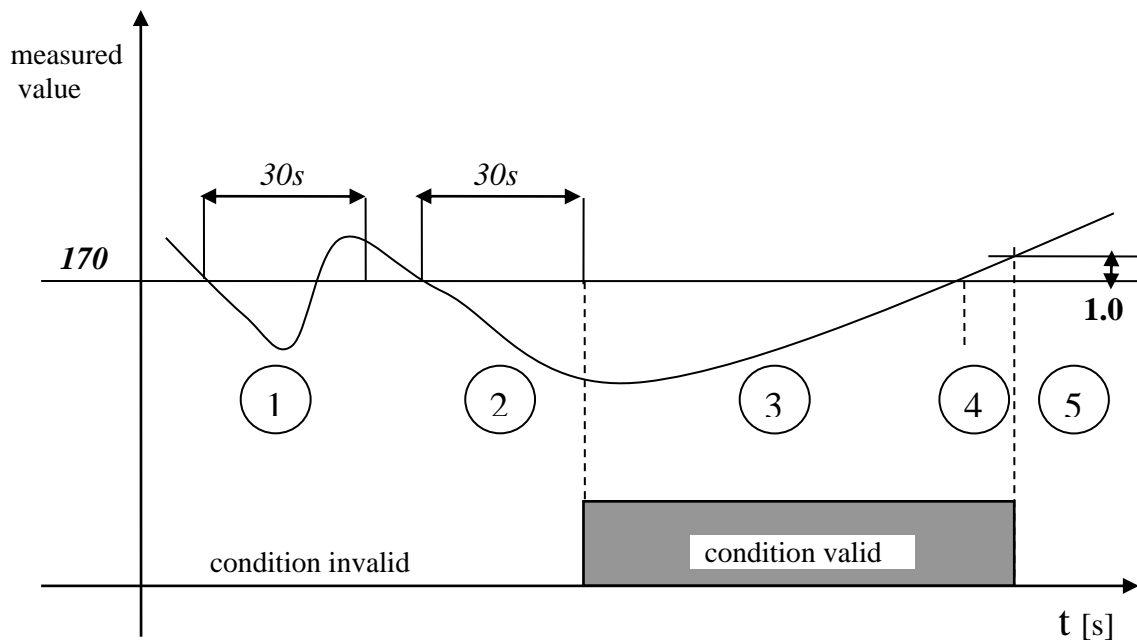

- *Condition with fixed specified time validity*

Condition 1

Start of validity:  >  °C for the duration of  s

End of validity:    °C together with  expires  s

In the case of input error (measured value is not available):

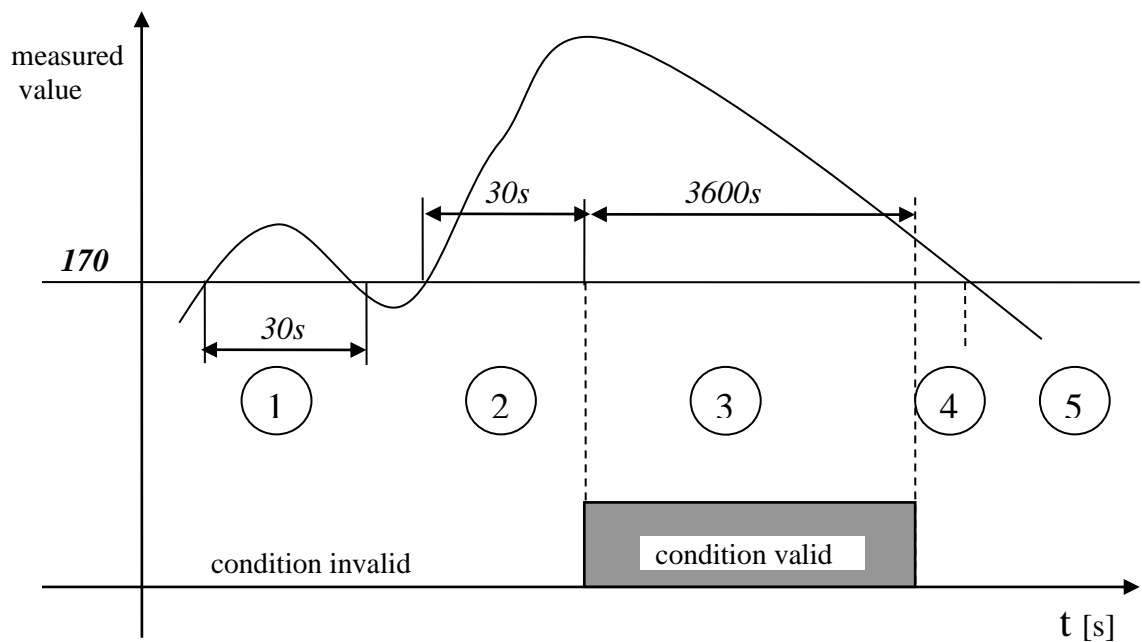

*To renew validity of condition measured value first must drop below specified limit and then to exceed the limit.*

- *Combination of condition validity termination with hysteresis OR after specified delay*

Condition 1

Start of validity:  >  °C for the duration of  s

End of validity:  value returns back with hysteresis  °C or  expires  expires  s

In the case of input error (measured value is not available):

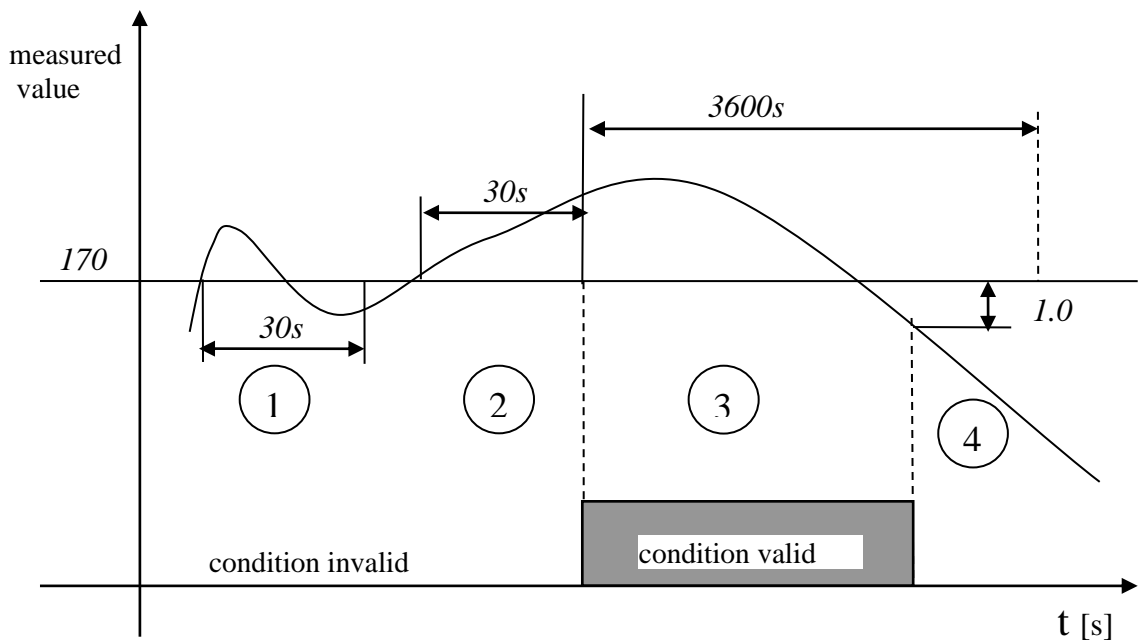
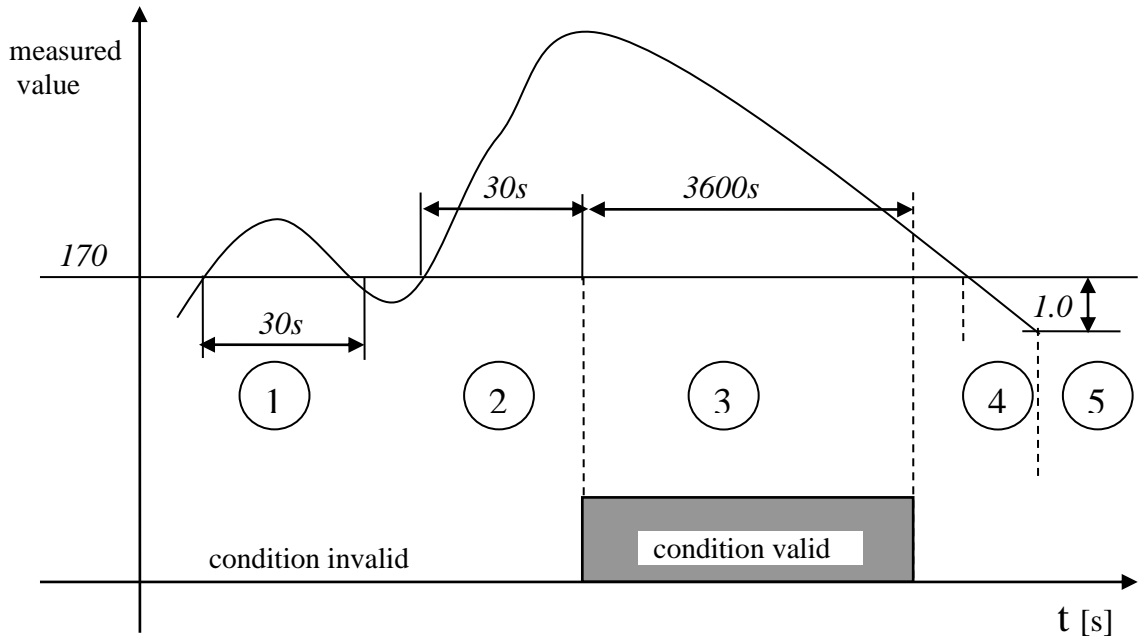

*To renew validity of condition measured value first must drop below specified limit and then exceed the limit.*

- *Combination of condition validity termination with hysteresis AND after specified delay*

Condition 1

Start of validity:  >  °C for the duration of  s

End of validity:  value returns back with hysteresis  °C together with  expires  s

In the case of input error (measured value is not available):

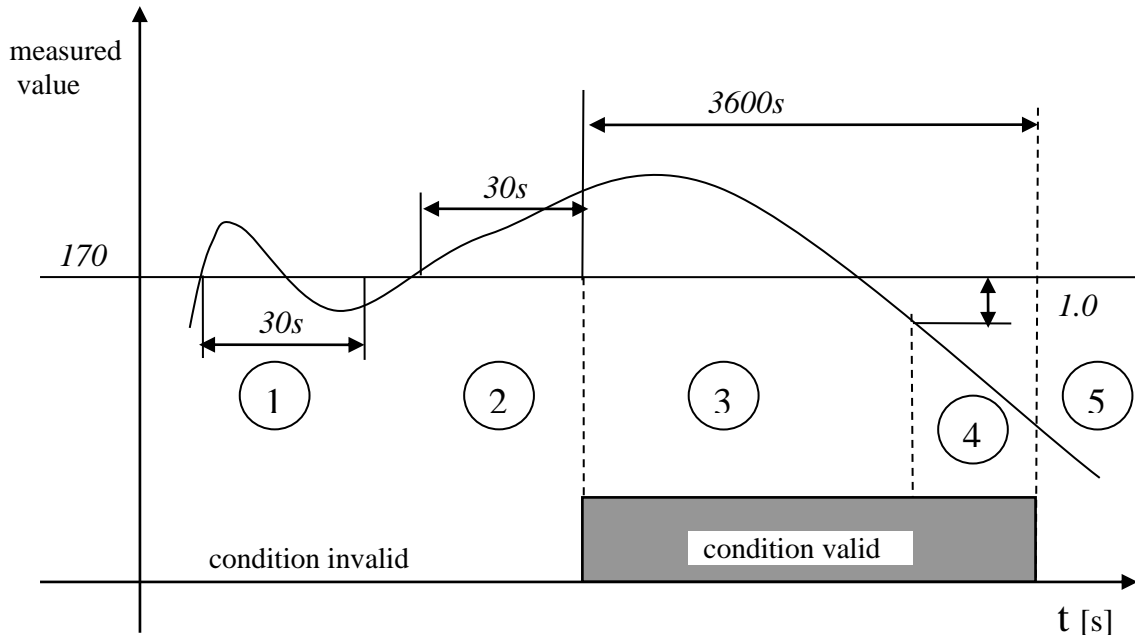

- B) if there is a need to control validity of condition only by date, time and day in the week, use selection **Valid in time interval**

*Example:*

Condition 1

Start of validity:

valid daily in time interval

from  to

valid only in interval

from   to

valid on selected days

Monday  Friday  Tuesday  Saturday  Wednesday  Sunday  Thursday

- C) if there is a need to control validity of condition directly from computer, use selection **Set remotely from PC**. In this case authorized access by user PIN code entering is enabled (if using *Administration of users and passwords*). If condition number 4 is set this way on any input channel, condition can be controlled also by means of SMS messages.

*Example:*

Condition 1

Start of validity:



**6.7. Bookmark *Ch..Alarms and indication***

Two alarm states for each channel are enabled to define. Several actions are enabled to assign to each alarm. Alarms are defined based on validity of *Conditions* or based on logical *Combinations of conditions* (maximum four conditions from different channels).

Wiring diagram of possibility of alarm states creation and associated actions:

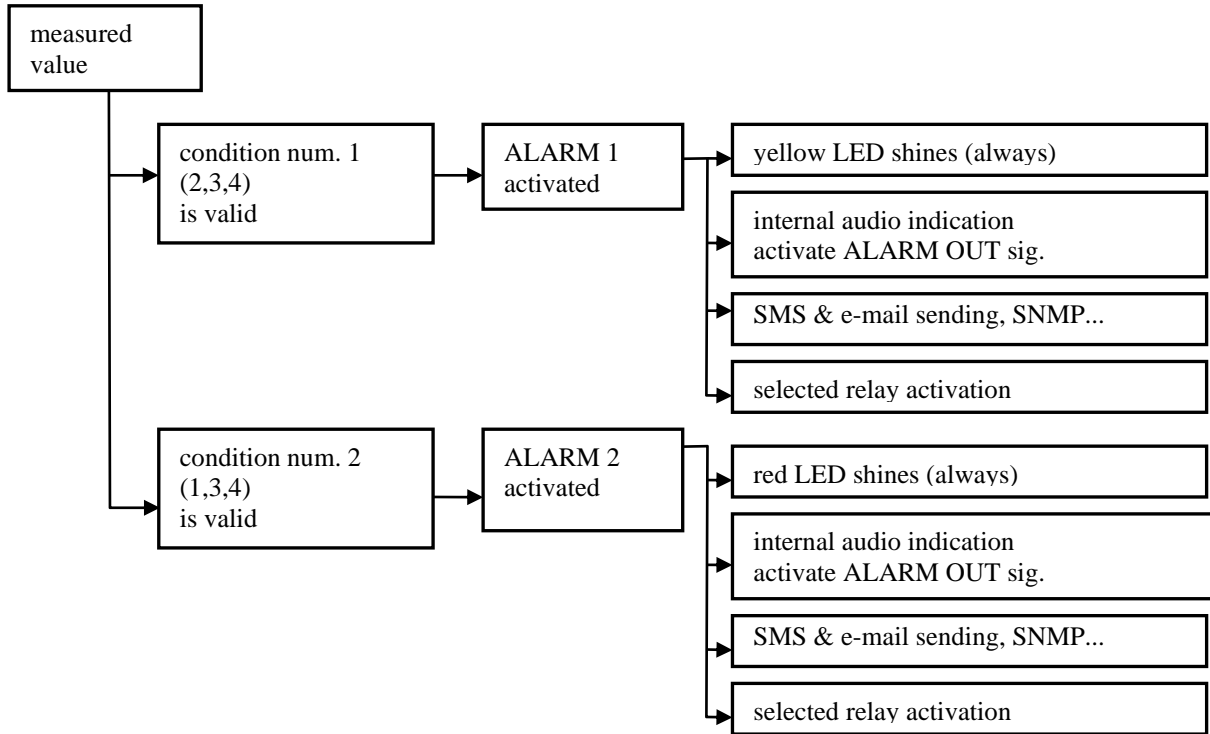

*Example of alarm creation at used logical combination of conditions:*

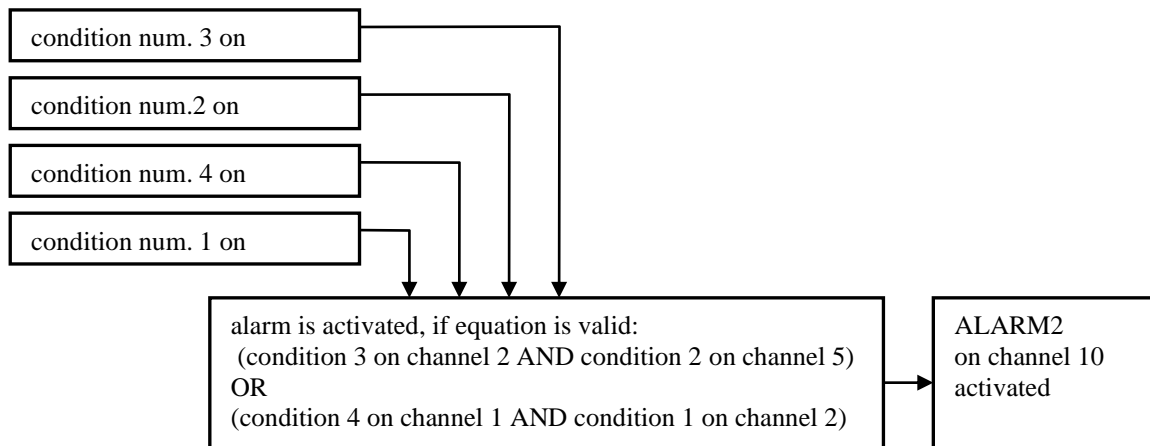

Alarm is active, if input conditions are valid. By means of combination of conditions you can solve also complex situations including remote control. Some actions last during all alarm time (audible indication, ALARM OUT output activity, visual indication, relay closing), other actions last only at the moment of alarm creation (SMS message, e-mails). Changes of ALARM OUT output state or all alarms state can be recorded.

## 7. APPLICATION NOTES

### 7.1. *Processes and how to work with*

Process is the name of action recorded by data logger in time. User of data logger can enter from its keyboard to each input channel (except binary inputs) different previously preset names of processes and such way to distinguish in record, which action was performed at that time. Example can be smoke-box for meat. During one working shift different products are processed consequently (names are known before and stored in data logger).

Way of work with processes:

- In configuration of data logger write to *Process label list* all processes (e.g. kind of products) meant for the data logger. Maximum processes is 16 and each process name can contain maximum 16 characters
- select for each channel, which processes will be used (all-some-no). This selection simplifies choosing process (kind of product), when only relevant processes will be offered for the channel.
- at the beginning of the process (e.g. after inserting one kind of product to the meat smoke-box) user finds the desired input channel and presses and holds ENTER key on the data logger keyboard. The name of the first process is displayed. By means of arrow keys preset name corresponding with the product can be selected. By pressing ENTER key again this process in data logger will be activated.
- when the operation is finished and user requires another process (e.g. another kind of product is inserted to the meat smoke-box), it is activated in similar way. Optionally no process is assigned.
- after recorded data download to the PC each time section of the record will be described with name of process, which was active in specified time
- by short pressing of ENTER key on data logger it is possible to display actually active process

Using of Processes is not possible with binary channels (S, SG, S1).

### 7.2. *SMS message and how to work with*

If data logger is connected to modem with support SMS function, it is possible enable the following action:

- response on incoming SMS queries, when following possibilities exist:
- a) **Info** – if SMS is sent to modem with this text (both capital/lower-case letters are allowed), SMS response is received containing basic information on data logger (type, name, memory occupation, channel names, measured values and alarm states). This SMS can consist of up to four partial SMS messages depending on configuration of data logger. One long SMS can be displayed on mobile telephones with support of long SMS.
  - b) **Alarm** - if SMS is sent to modem with this text (both capital/lower-case letters are allowed), SMS response is received containing basic information on data logger (type, name) and channel numbers in active alarm states.
  - c) **Ch1** - if SMS is sent to modem with this text (both capital/lower-case letters are allowed), SMS response is received containing basic information on data logger (type, name), channel 1 name, actual measured value and alarm state at channel 1. For other channels enter corresponding number (e.g. Ch11 for channel 11).
  - d) **Set1** resp. **Clr1** – if SMS with this text is sent to modem (both capital/lower-case letters are allowed), then manual control of so called Remote condition by means of SMS messages is enabled. Command **set**<number of channel> activates condition number 4 on selected channel. Command **clr** < number of channel > deactivates this condition. Control of condition number 4 by means of SMS can be performed on any channel. Condition must be set to Remote (Setting from PC). Answering SMS is received containing basic information on data logger (type, name) and actual status of set condition. In case security system with passwords is used, then PIN code will

be required in manipulation with this condition. Insert space character behind command *Setn* then insert space character and corresponding PIN code (e.g. *Set8 1234*). In case of error (incorrect condition setting or incorrect PIN code) answer contains error message instead of status of set condition.

- sending of SMS with alarm report - in case alarm at one of input channels appears, data logger can activate modem and send SMS message. Up to four telephone numbers are enabled to enter to common parameters. It is possible to select for each alarm at each channel to which telephone number SMS message will be sent. If alarm state of measured value appears, data logger sends SMS in above format **Alarm**. If critical state in data logger appears, one SMS is sent with specification of data logger type, name and names of critical states (error of configuration, measurement, selftest or memory occupation limit).

*ATTENTION – Data logger has no information on state of credit on SIM card. Use suitable tariff ensuring reliable SMS messaging.*

More detailed information on support of SMS messages are in **Appendix No.8**.

### **7.3. Possibilities of setting Logging interval**

Logging interval is for each record mode (continuous, conditional) and for each channel individually selectable. These intervals are available: 1 s , 2 s, 5 s, 10 s, 15 s, 30 s, 1 min, 2 min, 5 min, 10 min, 15 min, 30 min, 1 h, 2 h, 3 h, 4 h, 6 h, 8 h, 12 h, 24 h. Storing is performed always in whole number multiples of above intervals. E.g. *if data logger is switched on at 5:05 and the interval is set to 1 hour, first data are stored at 6:00, next at 7:00 etc.* Additionally, to above logging intervals record is enabled also in alternative daily time. Maximum of four alternative logging times can be defined for entire data logger. For each channel is possible to select from them.

*Note: Data logger measure one channel after another. Measurement of one channel takes approximately 80 ms. It means if all 16 channels are active, the total measurement time is about 1.3 s. This is important with shortest logging intervals.*

### **7.4. Identification of person, who deactivated alarm**

- switch on administration of users and passwords
- define PIN code for each user in part *User account* and switch on *Alarm confirmation by PIN1*
- check if option *Confirmation of alarm signalization by menu* is switched ON and option *by enter key* is switched OFF.

### **7.5. Way of entering PIN code from data logger keyboard**

Data logger can work with two kinds of PIN codes:

- PIN1 codes related to particular usernames and used to cancel alarm and for remote setting of conditions - maximum 16 PINs
- PIN2 code designed only for protection of data logger configuration against undesirable changes from data logger keyboard. This code is only one for all secured selections and has no relationship with *Administration of users and passwords*.

Way of entering PIN code:

- on data logger LCD is displayed requirement Enter PIN and four asterisks
- by means of arrow keys enter first (highest digit) and press Enter
- after entering the last digit and pressing button Enter validity of PIN code is checked. If valid editing of selected item is allowed
- if you make an error in entering code, press several time button Enter to get back to the beginning of entering PIN code and repeat the whole action

### **7.6. Sharing of Display mode on several computers together with automatic storing of data on network**

- Optional SW version is required
- On the computer connected to data logger set in operation system After Start user program of MS monitoring system.

- Run program and in menu File – Options on bookmark Folder and data files enter path to server where data will be stored.
- At bookmark Display tick Run at program start and tick below Remote www access. Note specified computer name or IP address.
- At bookmark Automatic download select day and hour of data download, optionally other selections and confirm window.
- Check in menu Configuration- Communication settings, if automatic data download is allowed for data logger – "A" and "D" must be ticked next to data logger name (A as Active, D as autoDownload). If not, tick it (by box checking or due to *Edit* button).
- Restart the computer. A while after user MS program would run with Display mode.
- Go over another computer and in internet browser to the Address filed enter computer name you have noted before. You would see www pages with actual measured values.

*If data logger is equipped with Ethernet interface, then www pages of data logger are accessible without the need user PC program is running.*

**7.7. *How to ensure alarm report, in case of power failure***

Data logger can be set in the way relay of ALARM OUT output will be closed in the state without alarm and will only open in the alarm state. Such inverse configuration can be set in advanced menu of the SW. Then it is sufficient to back up with batteries only suitable alarm dialer (e.g. telephone dialer) and state without power for data logger will correspond with alarm state, which causes alarm report to the user. Description of setting is specified in **Appendix No. 5**.

**7.8. *Back-up of data logger configuration and its restoring***

If there is a need to back up data logger configuration to the computer and have the possibility to upload the configuration to the same or another data logger, read record from data logger. Stored file on disk contains among others also complete configuration of data logger. If you use selection in menu *Configuration – Reading configuration from file*, you can display this configuration and store to the connected data logger. If connected data logger has different serial number from numbers stored in file, this number and some other items related to particular board will not be overwritten. The rest of configuration is stored to the data logger.

**7.9. *How to set variable condition limit according to measured value on other channel?***

Set up *Type of input channel* to *Interchannel recalculation* and assign another channels difference to it. Set condition limit to zero for this channel. This function reduced number of useabled channels by one.

**7.10. *Can be confirmation of alarm signalization applied to acoustic alarm only?***

Yes, it is possible for MS6 data logger with firmware version 6.3.0 and later. The settings are possible at the Common bookmark - Confirmation of alarm signalization – button Advanced. Use the latest version of software.

**7.11. *It is possible to force confirmation of alarm signalization again after some time?***

Yes, it is possible for MS6 data logger with firmware version 6.4.0 and later. The settings are possible at the Common bookmark - Confirmation of alarm signalization – button Advanced. You can set the time period after which the alarm signalization is activated again, even if alarms have not changed. Use the latest version of software.

**7.12. *What is it “latched alarms”?***

If any alarm is appeared, it stays active regardless the measured values. This state persists until to the confirmation of alarm signalization when the alarms are set according to the actual measured values. This feature is available for MS6 data logger with firmware version 6.3.0 and later. Description of setting is specified in **Appendix No. 5**. Use the latest version of software.

### 7.13. Other possibilities in data logger configuration

Some settings are not accessible to usual users and are designed for qualified user. The work is described in Appendixes and special *Service manual*.

### 7.14. What to do if data logger does not work

- Does the LED diode light on power source (if there is any)? – if not then there is no mains voltage or the source is faulty or the fuse is broken (then the cause can be in data logger). Check connection of power to data logger. If the fuse breaks after source plug in mains disconnect all terminals and connectors except power from data logger and try again. If it works connect cables one after another and try to find the failure.
- Does the LED diode light on power source? - if not replace fuse in data logger. Use the same type!
- If the LCD display is off and data logger does not communicate probably qualified repair will be necessary.

### 7.15. Self test error

If self test is not OK, data logger after switching ON reports self test error with specification of incorrect voltage (power voltage, internal battery and negative source voltage). If error in Ucc, try to measure the power voltage on data logger. It is necessary to fix the failure. If sending of SMS message in selftest error is set, use suitable delay, e.g. 30 s.

### 7.16. Problems with correct measurement

- Data logger measures incorrectly at some inputs:  
*Disconnect all inputs and let connected always only one and watch values on data logger. If correct then problem can be in cabling or in input device (incorrect connection, undesirable loops).*  
*Typical values on display when current loop is open (4 to 20) mA for several selected input ranges:*

Assignment of input value for current 4 to 20 mA in user calibration	measured value by data logger if current loop is open
-30 to 60	-52,5 or Error1
-30 to 80	-57,5 or Error1
-50 to 30	-70,0 or Error1
0 to 150	-37,5 or Error1
0 to 100	-25,0 or Error1

Message Error2 with current loops indicates exceeding of current 20 mA

*In case of measurement of resistance (e.g. sensors Pt100, Pt1000, Ni1000 and others) the following errors can appear: Error1: short circuited sensor  
Error2: broken sensor*

Data logger time from time and totally irregularly indicates totally incorrect value:

*Failure shows nonsensical value in record, on the display and short alarm activation. Most probably it is caused by electromagnetic interference. Effect is typical if correct rules for installation are not followed. It is necessary to check cabling, to change cable routing, to try to reduce interference etc. Most often this effect appears with current loops powered from data logger, which are connected to transducers of resistance sensor to current, if resistance sensor shielding is not connected properly or shielding is perforated to ground of other devices. Adjust suitable alarm delay  $t_{ON}$  (see setting conditions) in risky installations. Also faulty probe or transducer can cause such troubles.*

### 7.17. Problems in communication with computer

*Possibilities of trouble shooting of usual problems can be found in Appendix No. 3 at concrete communication interface.*

## **8. RECOMMENDATION FOR OPERATION AND MAINTENANCE**

### **8.1. *Operation of data logger in various applications***

Before application it is necessary to consider if data logger is suitable for required purpose, adjust optimal configuration and create instructions for its periodical metrological and functional verifications.

Unsuitable and hazard applications: data logger is not design for applications, where failure of operation could cause endanger of health or function of other device supporting life functions. In applications, where failure of data logger could cause loss on property, it is recommended to amend system of independent indication device to monitor this state and avoid damages. It concerns especially control and indication outputs of data loggers. In critical applications it is suitable to power data logger from backed-up sources (UPS) dimensioned to required operation without mains power. Furthermore critical can be data logger connection to power itself. *It is not suitable to power both data logger and critical device – e.g. freezing box – to one fuse. If fuse is disconnected, then neither data logger nor monitored device is working. In such applications it is useful to set inverse behavior of output ALARM OUT when status without alarm is signaled by closed relay.*

Location of temperature transducers: locate them to places with sufficient airflow and where most critical point is supposed (in accordance with application requirements). Transducer must be located sufficiently inside of measured room or be connected to, to avoid thermal influence of leading wires to measured temperature. *In monitoring of temperature in air-conditioned room, do not locate transducer to direct flow of air conditioning unit. E.g. at large chamber refrigerators can be temperature profile very inhomogeneous, deviations can reach up to 10 °C.*

Location of humidity transducers: in measuring of humidity in refrigeration boxes without additional humidity stabilization, strong changes of humidity can occur in switching on/off the refrigeration (up to tens of % RH) even though mean RH value is stable.

Optimum data logger operation: it depends on particular application. Important is the setting of logging and alarm parameters. It is necessary to take into account the memory capacity of data logger and frequency of data transfer to the computer. Select logging mode depending on preferable way of data management. If newest data are preferred select cyclic mode, if oldest data are preferred, select noncyclic mode. Further more consider if data will be erased from data logger after data transfer to the computer. In case data will be erased, then a long-term record is not stored in one file and it is not possible to identify eventual failures. In case memory is not erased, then data transfer duration to computer can be a problem. If there are problems with data logger, it is recommended not to erase data.

Alarm delay and hysteresis settings are very important.

### **8.2. *Recommendation for metrological verification***

Metrological verification is performed in accordance with application requirements specified by the user. One year the manufacturer recommends periodical verification.

Notice: *accuracy of data logger input means accuracy of input itself without probes.*

In verification of thermocouple inputs it is necessary to take into account that cold end compensation is perform inside of data logger, where temperature is mostly slightly higher than ambient temperature on the outer connector. Best way is verification together with connected thermocouple.

### **8.3. *Recommendation for periodical verification***

Manufacturer recommends periodical verification of the system yearly. Interval and range of verification depends on the application. In stationary installations following verification is recommended:

1. Metrological verification
2. Regular overhaul in intervals accordingly to corresponding standards
3. Evaluation of all problems from the last verification
4. Visual inspection of data logger
5. Functional verification of data logger (functions used in application):
  - A) verification of data transfer to computer

- B) verification of alarms – change input value to activate alarm and check on display and also in external audio indication (if used)
  - C) evaluate in data logger if relay contacts live
  - D) evaluate internal battery – third value in self test must be at least 2.6 V
6. Verification of cabling – check the connection quality of cables, check visually entire cable length for damage and the route of cables for interference, especially whether some parallel power wires are not near.
  7. Visual inspection of transducers for possible interference or water penetration.
- Make a verification protocol.

#### **8.4. Recommendation for service**



Service of data logger is made at manufacturer or authorized partner. There is no service allowed without authorization from manufacturer. Unauthorized encroachment leads to loss of all warranty. *The most common damage due unauthorized manipulation with input modules is damage of the motherboard when modules are connected in improper way.*

#### **8.5. Placing out of operation after end of device life**

Disconnect the power cord and return data logger to the supplier or specialized company. Notice: *data logger contains back-up Lithium battery on motherboard and on each counter input module (CTU, CTK)*

## 9. TECHNICAL DESCRIPTION AND PARAMETERS OF DATA LOGGER

### 9.1. Circuit concept of data logger

Data logger is designed as autonomous complex controlled by its own microprocessor, which fully works if power voltage is connected. If power voltage is not present, data logger does not work, but recorded data and internal time are saved.

### 9.2. Not allowed manipulation and warning



Power source is a device connected to electric mains and if it is damaged including power cord there is danger of injury by electric current. It is not allowed to connect it to mains if power cord is damaged or if its cover is damaged or removed. It is also not allowed to place it in humid and dangerous environment (e.g. bathroom etc.), at points exposed to direct sun radiation and other thermal sources, to prevent damage and deformation of the case. For safety reasons it is not allowed to connect to data logger terminals higher voltage than 24V.

### 9.3. Technical parameters of data logger

#### 9.3.1 Power

Data logger is powered from external ac/dc adapter or from other suitable DC source.

Power of data logger	
Power voltage:	24 V DC (24V±3V) <sup>(2)</sup>
Maximum consumption:	25 W <sup>(1)</sup>
Recommended power source:	SYS1308-2424-W2E or ENCO NZ 21/25/1000
Protection:	tube fuse F2A on mother board
MS6-Rack power connector:	circular 5.5/2.1 mm power connector or terminal

<sup>(1)</sup> It concerns maximum consumption with 16 inputs of configured as 4 mA...20 mA with short circuited input terminals +24V and COM.

<sup>(2)</sup> Detailed information on power voltage for data logger and current consumption is specified in Appendix No.1.

#### 9.3.2 Output relay module for data logger

Module contains 16 mains relay with switching-over contacts connected to self-locking Wago terminal on the module. Each relay has three terminals available.

Maximum voltage on the contact:	MP018: 250 V AC* MP050 in MS6-Rack: 50V AC/75V DC max.
Maximum current through the contact:	8A
Maximum switching power:	2000 W
Mechanical life of relay contact:	3 x 10 <sup>7</sup> cycles
Electric life of relay contact:	1 x 10 <sup>5</sup> cycles
Material of contact:	Ag Cd O
Maximum wire cross section in terminal:	1,5 mm <sup>2</sup>
Dimensions:	140 x 211 mm
Mounting (MP018):	MP019 on DIN rail 35mm or MP013 holders

\*... Pay attention to all required safety rules in mounting and during operation!

#### 9.3.3 Output ALARM OUT

This output is designed especially for connection of external audio indication or telephone dialer. Way its activation can be programmed in data logger configuration. Output is available both in voltage version and as galvanically isolated relay contact.



Parameters of output ALARM OUT in activation:	approximately 4.8 in DC, maximum 50 mA
Parameters of inactivated output:	0 V, no load allowed
Connection:	terminal Wago
Length of connection cable:	maximum 100 m, only at indoor environment
Used relay	250 V AC/ 8 A
Maximum connectable voltage on relay and current	24 V AC/ 1 A

Galvanic isolation is not designed for safety function (not sufficient isolating distances).  
The case of external audio indication is designed for wall mounting and the connection is by means of connector CINCH (outer contact – GND, central pin – ALARM OUT).

### 9.3.4 Communication interface

Each data logger is equipped with interface RS232C, RS485 and USB. Ethernet interface is optional. Communication interfaces are mutually connected internally and as one functional unit galvanically isolated from other data logger circuitry. Communication with data logger is enabled only via one selected interface. Status of other interfaces does not effect this communication (it is set on the display of data logger v menu).

<b>RS232C:</b>	Used signals:	RxD, TxD, GND RTS-CTS selectable from SW
	Galvanic isolation:	electrical strength 500 V DC
	Connector:	DSub 9 male, signals DTR-DSR are connected
<b>RS485:</b>	Maximum cable length:	15 m, only in indoor environment
	Input impedance:	approximately 12 kΩ
	Galvanic isolation:	electrical strength 500 V DC
<b>USB</b>	Connection:	dual terminals
	Maximum cable length:	1200 m in indoor environment
	Compatibility:	USB1.1. and USB 2.0
	Connector:	USB type B
	Vendor ID:	0403
<b>Ethernet</b>	Product ID:	6001
	Compatibility:	10/100 MBit Ethernet, galvanic isolated
	Connector:	RJ45



Galvanic isolation is not designed for safety function - protection against electrical current injury!

the way of communication	
Setting of communication	serial link, 1 start bit, 8 data bits, 1 stop bit, without parity
communication speed	1200Bd <sup>1)</sup> , 9600Bd, 19200Bd, 57600Bd, 115200 Bd, 230400Bd <sup>2)</sup>

<sup>1)</sup>...this speed is adjustable only for SMS messages transmission by means of interface RS232

<sup>2)</sup>...only for communication with the PC. If the speed is supported by data logger, it suitable for USB (COM ports of the computer generally does not support this speed).

#### Serial interface for reception and sending SMS message:

This interface serves for data logger communication with GSM modem for reception and sending of SMS messages. Interface is wired always to RS232 connector.

If data logger is set for communication with computer via other interface than RS232, then in case of enabled SMS messages support data logger communicates in 10s intervals with modem to evaluate state of received SMSs and sent alarm SMSs.

In case data logger is set to main interface RS232, then it is supposed, data logger has connected GSM modem to this interface. Interface is used both for SMS and for communication with computer. SMS messages evaluation is performed with the 2 minutes interval, but only in case, no communication with the PC is in progress. If communication with the PC is in progress, SMS interface waits until channel is free.

### 9.3.5 Data memory

---

Total memory capacity:	up to 480 000 analog values (count of binary values can be more)
------------------------	--

---

### 9.3.6 Real time clock circuitry

Contains actual data with seconds, minutes, hours, days, months and years. Circuitry works even if data logger is disconnected from power.

---

Error of time value:	maximum 255 ppm $\pm$ 5 ppm/year at temperature 23 °C $\pm$ 10 °C
----------------------	---

---

### 9.3.7 Internal battery

Serves to back-up recorded data and to power of real time clock (RTC) in case, data logger is not connected to power.

---

Type of battery:	Lithium 3 V, VARTA CR ½ AA
Estimated life:	10 years from date of production of data logger

---

### 9.3.8 Electromagnetic compatibility

Device is tested in accordance with EN 61326-1: 2006 article 6 table 1

---

radiation:	EN 55022 ed. 2 class B
immunity:	EN 61000-4-2: class B (4/8 kV)
	EN 61000-4-3: class A (3 V/m)
	EN 61000-4-4: class A (0,5/1 kV)
	EN 61000-4-5: class A
	EN 61000-4-6: class A (3 V)

---

### 9.3.9 Operating condition

---

Operating temperature:	(0..50) °C
Operating humidity:	(5 .. 85) %RH
Settling time after switching ON:	15 minutes

---

### 9.3.10 Storing condition

---

Storing temperature:	-10 to +70 °C
Relative humidity:	5 to 95 %

---

### 9.3.11 Mechanical parameters

---

Dimensions of the MS6D case:	215 x 165 x 44 mm without connectors and without mounting consoles
	215 x 225 x 44 mm with connectors and without mounting consoles

---

Dimensions of the MS6R case:	165 x 230 x 44 mm without connectors and without mounting consoles 225 x 230 x 44 mm with connectors 483 x 230 x 44 mm with mounting consoles to rack 19''
Dimensions of the MS6-Rack case:	483 x 190 x 44 mm without connectors
Weight:	approximately 800 g
Protection:	IP20
Input terminals:	removable, maximum cross section of lead: 1.5 mm <sup>2</sup>
Mounting:	desk top – standard version (MS6D or MS6R) by means of two mounting consoles – optional accessory for MS6D by means of DIN rail 35 mm holder – optional accessory for MS6D by means 19'' rack mounting consoles – MS6R

## 9.4. Technical parameters of inputs

Every input channel can be set by means of user SW for measurement of different electrical values. It requires correct wiring of input terminals. Analog inputs are not mutually galvanically isolated. For the need to recalculate measured values menu item Recalculations in user program is designed to configure data logger. Here it is possible to assign measured values required values by means of two-point linear transformation. Then accuracy specification must be recalculated in corresponding way.

### 9.4.1 Absolute limit values



Exceeding of those values can cause damage of data logger or undesired influence to its behavior.

terminal	limit values
+Up	short circuit against IN, COM and GND is possible no external negative voltage against GND terminal can be connected
IN	±24 V DC against COM or GND
COM	±6V or ±50 mA against GND
GND	

### 9.4.2 Recommended operating conditions

terminal	recommended operating values
+Up	power of connected transmitters at range 0 to approx. 25 mA against terminal COM or GND or not connected
IN	at range -10 V...+10 V DC against COM or GND or not connected
COM	at range -3 V...+3 V or -25 mA...+25 mA against GND or not connected
GND	

### 9.4.3 Parameters of input ranges

	terminal +Up	
switch position	+24 V	+12 V
no load voltage	approx. 23 V	(13,2..13,6) V
internal resistance @23 °C	125 ohms	
current limiter	thermistor	
voltage @20mA	approx. 21.5 V	approx. 12 V

#### Input for measurement of dc current (4 to 20) mA

Measured value:	dc current, from active source connected between terminals COM and GND or passive transmitter connected between terminals +Up and COM
Range:	(4.. 20) mA
Accuracy:	0.1 % from range ( $\pm 0.02$ mA)
Input resistance:	110 $\Omega$ (across COM and GND terminals)
Current in short circuit of input terminals +Up and COM:	at the moment of short circuit approx. 130mA, after approx. 10 sec limited to approx. 40 mA (valid for switch at +24V position)
Voltage across open terminals +Up a COM:	approx. 22V with current 4 mA and approx. 19V with current 20mA

#### Input for measurement of dc voltage -10V to +10V

Range:	(-10... +10) V
Accuracy:	0.1 % from range ( $\pm 10$ mV)
Input resistance:	approx. $10^7 \Omega$
Input terminals:	IN a COM

#### Input for measurement of dc voltage -1V to +1V

Range:	(-1...+1) V
Accuracy:	0.1 % from range ( $\pm 1$ mV)
Input resistance:	approx. $10^7 \Omega$
Input terminals:	IN a COM

#### Input for measurement of dc voltage -100mV to +100mV

Range:	(-100... +100) mV
Accuracy:	0.1 % from range ( $\pm 100$ uV)
Input resistance:	approx. $10^7 \Omega$
Input terminals:	IN a COM

#### Input for measurement of dc voltage -18mV to +18mV

Range:	(-18... +18) mV
Accuracy:	0.1 % from range ( $\pm 18$ uV)
Input resistance:	approx. $10^7 \Omega$
Input terminals:	IN a COM

Inputs for measurement of thermocouple (except thermocouple type B) have compensation of cold junction temperature inside of data logger. Compensation *temperature is measured on data logger motherboard between terminals for channel 8 and channel 9*. Value of this temperature is converted to thermoelectric voltage and added to value of thermoelectric voltage measured by thermocouple. Result is converted to temperature again, which is resulting measured temperature. If using thermocouples operate data logger in working position with input signal terminals towards down and do not install heat sources in the **neighborhood**.

<b>Input for temperature measurement by thermocouple „K“</b>	
Measured value:	temperature measured thermocouple type K (NiCr-Ni)
Range:	(-200...1300) °C
Accuracy (without probe):	± (0.3 % from measured value + 1,5 °C)
Cold junction:	compensated at temperature range (0..50) °C
Input terminals:	IN and COM
<b>Input for temperature measurement by thermocouple „J“</b>	
Measured value:	temperature measured thermocouple type J (Fe-Co)
Range:	(-200...750) °C
Accuracy (without probe):	± (0.3 % from measured value + 1,5 °C)
Cold junction:	compensated at temperature range (0..50) °C
Input terminals:	IN and COM
<b>Input for temperature measurement by thermocouple „S“</b>	
Measured value:	temperature measured thermocouple type S (Pt10%Rh-Pt)
Range:	(0...1700) °C
Accuracy: (without probe):	± (0.3 % from measured value + 1,5 °C)
Cold junction:	compensated at temperature range (0..50) °C
Input terminals:	IN and COM
<b>Input for temperature measurement by thermocouple „B“</b>	
Measured value:	temperature measured thermocouple type B (Pt30%Rh-Pt)
Range:	(100...1800) °C
Accuracy (without probe):	± (0.3 % from measured value + 1 °C) at range (300..1800)°C
Cold junction:	not compensated
Input terminals:	IN and COM
<b>Input for temperature measurement by thermocouple „T“</b>	
Measured value:	temperature measured thermocouple type T (Cu-CuNi)
Range:	(-200...400) °C
Accuracy (without probe):	± (0.3 % from measured value + 1,5 °C)
Cold junction:	compensated at temperature range (0..50) °C
Input terminals:	IN and COM
<b>Input for temperature measurement by thermocouple „N“</b>	
Measured value:	temperature measured thermocouple type N (NiCrSi-NiSiMg)
Range:	(-200...1300) °C
Accuracy (without probe):	± (0.3 % from measured value + 1,5 °C)
Cold junction:	compensated at temperature range (0..50) °C
Input terminals:	IN and COM

With inputs for resistance measurement and RTD transmitters current is connected to measured resistance only during measurement.

<b>Input for 2-wire measurement of resistance (0 to 300) ohm</b>	
Range:	(0 to 300) ohms
Accuracy:	0.1 % from range ( $\pm 0.3$ ohms)
Measuring current:	cca 0.8 mA at pulse approx. 50ms length
Input terminals:	IN and COM
<b>Input for 2-wire measurement of resistance (0 to 3000) ohm</b>	
Range:	(0 to 3000) ohms
Accuracy:	0.1 % from range ( $\pm 3$ ohms)
Measuring current:	cca 0.5 mA at pulse approx. 50ms length
Input terminals:	IN and COM
<b>Input for 2-wire measurement of resistance (0 to 10000) ohm</b>	
Range:	(0 to 10 000) ohms
Accuracy:	0.1 % from range ( $\pm 10$ ohms)
Measuring current:	cca 0.1 mA at pulse approx. 50ms length
Input terminals:	IN and COM
<b>Input for 2-wire measurement of resistance transmitter Pt100</b>	
Measured value:	temperature from RTD sensor Pt100/ 3850 ppm
Range:	(-200 .. 600) °C
Accuracy (without probe):	$\pm 0.2$ ° at range (-200..100) °C, $\pm 0.2$ % from value at range (100 .. 600) °C
Measuring current:	cca 0.8 mA at pulse approx. 50ms length
Input terminals:	IN and COM
<b>Input for 2-wire measurement of resistance transmitter Pt1000</b>	
Measured value:	temperature from RTD sensor Pt1000/ 3850 ppm
Range:	(-200 .. 600) °C
Accuracy (without probe):	$\pm 0.2$ °C at range (-200..100) °C, $\pm 0.2$ % from value at range (100 .. 600) °C
Measuring current:	cca 0.5 mA at pulse approx. 50ms length
Input terminals:	IN and COM
<b>Input for 2-wire measurement of resistance transmitter Nickel 1000</b>	
Measured value:	temperature from RTD sensor Ni1000/ 6180 ppm
Range:	(-50 .. 250) °C
Accuracy (without probe):	$\pm 0.2$ °C at range (-200..100) °C, $\pm 0.2$ % from value at range (100 .. 250) °C
Measuring current:	cca 0.5 mA at pulse approx. 50 ms length
Input terminals:	IN and COM
<b>Input for 2-wire measurement of NTC thermistor*</b>	
Measured value:	temperature from user definable NTC thermistor For further information see Appendix No.11.
Range:	lowest measured temperature corresponds to maximum measurable resistance of 11 000 ohms
Accuracy:	according to the used resistance range (300/3000/10 000 ohms)
Measuring current:	according to the used resistance range
Input terminals:	IN and COM

\* This feature is available for MS6 firmware version 6.2.0 or later.

Input configured for measurement of binary events works the way, during measurement internal source 2.5V with internal resistance of approx. 3000 Ohms is connected to the IN terminal IN. Input signal is connected between terminals IN and COM. Signal can be from potential-less contact, open collector or voltage. With voltage signal it is necessary to ensure, level L (zero voltage) is hard enough against this internal source. If output of connected device is at high impedance state, data logger evaluates the state as „H“.

<b>Input for monitoring of binary event</b>		
Input levels for „L“ state:	input voltage (IN – COM)	<0,8 V (R <sub>in</sub> < 1 kΩ)
	resistance of closed contact (IN – COM)	< 1000 Ω
Input levels for „H“ state:	input voltage (IN – COM)	> 2 V
	resistance of opened contact (IN – COM)	> 10 kΩ
Minimum length of input pulse:	200 ms	

#### **Galvanically isolated input for transmitters with serial output RS485** (optional accessories)

This input is designed for reading from intelligent transmitters, supporting basic form of protocol ModBus RTU or ADVANTECH. Transmitters are connected to special terminals next to terminals for channel 15 and channel 16. User can specify, which channels will read values from this interface instead of standard measurement. This input can cooperate with 1 up to 16 devices (resp. measured points). Module works that way, command for reading of data from the first transmitter is sent, then it waits for the response. Maximum waiting time is possible to set to approximately 210 ms. After waiting time error of communication is reported and reading of next channel continues. If device responds in adjusted time, response is evaluated and also reading of next channel continues. For all channels evaluated from this input communication speed and protocol must be the same.

Input communication interface:	RS485
Address of input device:	must be from interval 1 to 247 (decimal)
Communication speed:	(1200, 2400, 4800, 9600, 19200, 57600, 115200) Bd
Parity:	1 stop bit with odd/even parity, 1 stop bit without parity, 2 stop bits without parity
Transfer protocol:	ModBus RTU, Advantech
Impedance of input (reception):	approximately 12 k Ohms
Maximum length of cable:	1200 m at indoor rooms
Galvanic isolated:	500 V, not designed for safety function
Auxiliary power source:	approx. 24V/400mA max., galvanic connected with data logger

Note: *for more information see Appendix No.2.*

Contact address of this device's producer:

COMET SYSTEM, s.r.o.  
 Bezrucova 2901  
 756 61 Roznov pod Radhostem  
 Czech Republic  
[www.cometsystem.com](http://www.cometsystem.com)